

RADIO'S GREATEST MAGAZINE

RADIO-CRAFT

with
**POPULAR
ELECTRONICS**

HUGO GERNSBACH, Editor



SEE PAGE
528

JUNE

25¢

CANADA 30¢

1943

OVER 100 ILLUSTRATIONS

NEW TECHNICAL RADIO BOOKS

SEE THESE HELPFUL MANUALS AT YOUR RADIO JOBBER OR ORDER FOR EXAMINATION

Most - Often - Needed RADIO DIAGRAMS and Servicing Information

4 OUT OF 5 CIRCUITS YOU NEED

In these easy-to-use complete manuals you have all the diagrams you really need. Over 80% of the sets you service every day are included. Use these important, hint-giving, trouble-shooting circuits to make your service work faster and easier.



The manuals are large, 8½ x 11 inches, clearly printed on good quality paper. In most cases include fully detailed schematic diagram, parts list, alignment data, and service hints. Every popular diagram is included.

- 1942, Volume 5, 204 pages.... } **\$2.00**
- 1941, Volume 4, 192 pages.... } **EACH**
- 1940, Volume 3, 208 pages.... }
- 1939, Volume 2, 192 pages.... }
- 1926-38, Volume 1, 244 pages, alignment, hints, parts lists.. } **\$2.50**

GENERAL ELECTRIC MANUAL

This 64-page complete manual of the most-popular GE sets is something you must have. The entire manual of these "often-needed" important circuits is yours for less than the cost of a single diagram. Size 5½ x 8½ inches. **50c** Net Only

STEWART-WARNER MANUAL

This handy diagram manual contains diagrams, service notes, alignment data, for popular Stewart-Warner radios of all periods. Get this inexpensive book and be ready to service your next set of this important make. Size: 5½ x 11 inches. Price postpaid..... **50c**

ARVIN MANUAL

The most-often-needed diagrams of Noblitt-Sparks (Arvin) radios are included in this manual. Service these popular sets with confidence and skill, using this low priced radio publication. Size: 5½ by 11 in..... **50c**

MOTOROLA SERVICE MANUAL

This up-to-the-minute manual will tell you how to repair MOTOROLA auto radios. Includes detail schematics, service notes, alignment data, and parts lists for all of the 72 models made to 1941. Prepared with the help of Galvin Mfg. Co. engineers. This large 8½ x 11 inch, 96 page manual is priced postpaid at only..... **\$1.50**

Simplified Radio Servicing by COMPARISON Method



A NEW DEVELOPMENT

You will be able to repair radios in minutes instead of hours. Revolutionary different Comparison technique permits you to do expert work on all radio sets. Most repairs can be made without test equipment or with only a volt-ohm-meter. Many simple point-to-point, cross-reference circuit suggestions locate the faults instantly. Plan protected by copyright.

FOR BEGINNERS AND EXPERTS

This new, simplified servicing technique is presented in handy manual form 8½ x 11 inches, 112 pages. Covers every radio set type—new and old models. Over 1,000 practical service hints. 16 large, trouble-shooting blueprints. Charts for circuit test analysis. 114 simplified tests using only a 5c resistor. Developed by M. N. Beitman. Price Postpaid, only..... **\$1.50**

Practical Radio Mathematics

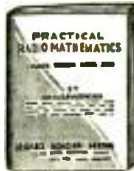

Introduces and explains the use of arithmetic and elementary algebra in connection with units, color code, meter scales, Ohm's Law, alternating currents, ohmmeter testing, wattage ratings, series and parallel connections, capacity, inductance, mixed circuits, vacuum tubes, curves, the decibel, etc., etc., and has numerous examples. Plainly written and easy to understand..... **25c**

TELEVISION FACTS

This book defines and explains every term and part used in television transmitting and receiving equipment. The more important terms are described in greater detail. You will find the TELEVISION CYCLOPEDIA Section an excellent introduction to television and a great aid in understanding more technical articles and books. Included are many photographs and charts to assist you. Every radio serviceman, amateur, and technician must have this book to understand television. 64 fact-packed pages, well illustrated. Price only

40c

HOW TO REPAIR REFRIGERATORS

This new practical book will tell you how to repair and adjust all domestic refrigerators. The old refrigerators in use must be repaired during the war. Get into this profitable field. Complete manual

40c

HOW TO MODERNIZE RADIOS

You can learn quickly to modernize all sets. Cash in by improving audio circuits, modernizing cabinets, adding features usually found on late model sets. Practical job-sheets with schematics and photographs make the work easy. You are told how to obtain modernization work, what to charge, and how to complete the job quickly and efficiently. Large size, 8½ x 11 inch, manual is priced at only..... **\$1.00**



SERVICE NOTES

on
RECORD PLAYERS
AUTOMATIC CHANGERS
WIRELESS UNITS
AND HOME RECORDERS

Just what you need to repair quickly and correctly thousands of automatic record changers, manual units, pickups, wireless oscillators, recorders, and combinations. Hundreds of mechanical and electrical diagrams. Instructions for adjustments and repairs. The most popular units of all makes included. 132 large pages, 8½ x 11 inches. **\$1.50** Net Price

LEARN RADIO

Home-Study Radio Course

AMAZING BARGAIN OFFER

Here is your chance to get your radio training almost free. These simplified, well illustrated, interesting lessons cover every phase of radio work. You will find the training remarkably easy to grasp and use.

\$2.50
COMPLETE

TRAIN AT HOME FOR A RADIO JOB

This home-study manual has helped others like you to secure high pay jobs in radio factories, service shops, War Industries, Navy and Army. These money-saving lessons will give you all the essential training needed. Includes extra information on recent radio developments. You may examine the complete course-manual, containing all the lessons and review questions, in your own home without any risk.

FOR BRUSH-UP AND REVIEW

Learn new speed-tricks of radio fault finding, case histories of common troubles, servicing short-cuts, extra profit ideas. Many large lessons on the use of regular test equipment, explanation of signal tracing, television to the minute, recording dope. With this information you will save enough time on a single radio job to pay the special \$2.50 price for the complete course of the money-making lessons. Many active servicemen used this reduced-price radio training for brush-up and study of new servicing methods.

NEW EDITION REPRINTED 1943

Reprinted in 1943 with information on signal-tracing, television, visual alignment, P.A., photo-cells, etc. All about AVC, how to use an oscilloscope, what is feedback, resonance action, and every other fact you must know to be more expert in your work. Order the course on a trial basis. Net price, only..... **\$2.50**

HOW TO ORDER BOOKS

Mark in the coupon the manuals you want. Then take the coupon to your radio jobber, or send the coupon to the publisher and receive the manuals selected, by prepaid parcel post.

SEE YOUR JOBBER OR SEND COUPON

SUPREME PUBLICATIONS

328 S. Jefferson St., Chicago, Ill.

I want the manuals listed below. I must be satisfied or you will refund my money.

I am enclosing \$_____ send postpaid. Send C.O.D.
NAME: _____
ADDRESS: _____

Supreme Publications

PUBLISHERS OF RADIO BOOKS, MANUALS, AND DIAGRAMS

328 South Jefferson Street

Chicago, Illinois



J. E. SMITH, President
National Radio Institute
Established 28 Years

I WILL SEND A SAMPLE LESSON FREE to PROVE I can Train You at Home in Spare Time to BE A RADIO TECHNICIAN

I Trained These Men



\$200 a Month in
Own Business

"For several years I have been in business for myself making around \$200 a month. Business has steadily increased. I have N.R.I. to thank

for my start in this field." **ARLIE J. FROEHNER**, 300 W. Texas Ave., Goose Creek, Texas.

Lieutenant in
Signal Corps

"I cannot divulge any information as to my type of work, but I can say that N.R.I. training is certainly coming in mighty handy these days." (Name and address omitted for military reasons.)



\$5 to \$10 a Week
in Spare Time

"I am engaged in spare time Radio work. I average from \$5 to \$10 a week. I often wished that I had enrolled sooner because all this extra money come in handy."

sure does **THEODORE K. DuBREE**, Horsham, Pa.

Extra Pay in Army,
Navy, Too



Men likely to go into military service, soldiers, sailors, marines, should mail the Coupon Now! Learning Radio helps Service men get extra rank, extra prestige, more interesting duties, **MUCH HIGHER PAY**. Also prepares for good Radio jobs after service ends. Over 1,700 Service men now enrolled.

Mail the Coupon for a FREE lesson from my Radio Course. It shows how N.R.I. trains you for Radio at home in spare time. And with this Sample Lesson I'll send my 64-page illustrated book, **WIN RICH REWARDS IN RADIO**. It describes many fascinating jobs Radio offers, tells how you can train for them at home in spare time.

More Radio Technicians and Operators Now Make \$50 a week Than Ever Before

There's a big shortage of capable Radio Technicians and Operators because so many have joined the Army and Navy. Fixing Radios pays better now than for years. With new Radios out of production, fixing old sets, which were formerly traded in, adds greatly to the normal number of servicing jobs.

Broadcasting Stations, Aviation and Police Radio, Ship Radio and other communications branches are scrambling for Operators and Technicians to replace men who are leaving. You may never see a time again when it will be so easy to get started in this fascinating field. The Government too needs hundreds of competent civilian and enlisted Radio men and women. Radio factories, with huge war orders to fill, have been advertising for trained personnel. And think of the **NEW** jobs Television, Frequency Modulation, Electronics and other Radio developments will open after the war! This is the sort of opportunity you shouldn't pass up.

Many Beginners Soon Make \$5, \$10 a Week Extra in Spare Time

There's probably an opportunity right in your neighborhood to make money in spare time fixing radios. I'll give you the training that has started hundreds of N.R.I. students making \$5, \$10 a week extra within a few months after enrolling. The N.R.I. Course isn't something just prepared to take advantage of the present market for technical books and courses. It has been tried, tested, developed, perfected during the 28 years we have been teaching Radio.

Find Out What N.R.I. Can Do for You

MAIL COUPON NOW for FREE Sample Lesson and 64-page, illustrated book. You'll see the many fascinating jobs Radio offers and how YOU can train at home. If you want to jump your pay—mail Coupon at once in an envelope or paste on a penny postal! **J. E. SMITH**, President, Dept. 3FX, National Radio Institute, Washington, D. C.

GOOD FOR BOTH 64 PAGE BOOK **FREE**
SAMPLE LESSON

Mr. J. E. SMITH, President, Dept. 3FX
NATIONAL RADIO INSTITUTE, Washington, D. C.

Mail me FREE, without obligation, Sample Lesson and 64-page book, "Win Rich Rewards in Radio." (No Salesman will call. Write plainly.)

Age.....

Name.....

Address.....

City.....State.....4FR-2



BROADCASTING STATIONS (top illustration) employ Radio Technicians as operators, installation, maintenance men and in other fascinating, steady, well-paying technical jobs. **FIXING RADIO SETS** (bottom illustration), a booming field today, pays many Radio Technicians \$50 a week. Others hold their regular jobs and make \$5 to \$10 a week extra fixing radios in spare time.

TRAINING MEN FOR
VITAL RADIO JOBS



RADIO-CRAFT

HUGO GERNSBACK
Editor-in-Chief

FRED SHUNAMAN
Associate Editor

G. ALIQUO
Circulation Manager

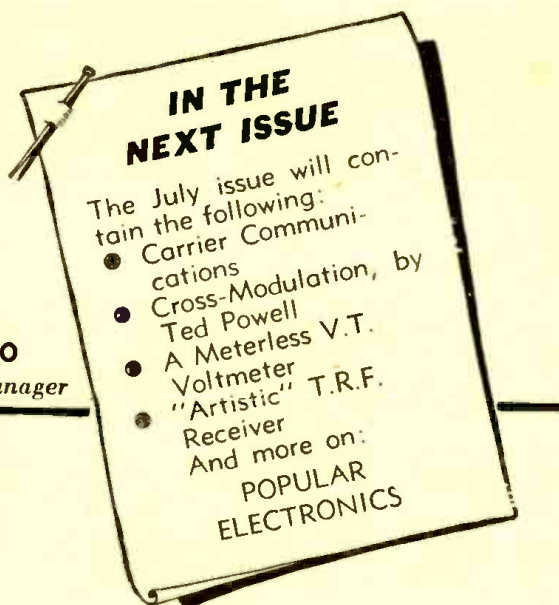

Contents **JUNE, 1943** **Issue**
VOLUME XIV -- NUMBER 9

Mailbag 516
 Editorial: Post-War Radio Developments by Hugo Gernsback 519
 The Radio Month in Review 520

POPULAR ELECTRONICS

Popular Electronics, Part V by Raymond F. Yates 522
 Electron Motor Drive With 20-1 Speed Range by T. R. Lawson 524
 Micro-Waves 525
 Precipitron 526
 Chemistry Now Speeded With Aid of Electrons by T. R. Rhea 527

WARTIME RADIO

Emergency Radio System Enlists Ham and Layman (Cover Feature) 528
 No More New Parts 529

SERVICING

Never Take It for Granted by Marion Crowell 530
 How Meters Are Repaired by F. J. Lingel 531
RADIO SERVICE DATA SHEET:
 No. 334 Emerson Model FH-413 and FH-440 532
 Home Radio Repairing Is Costly Nonsense by Fred Shunaman 534
 The Servicing of 3-Way Portables by John Kearney 535

SOUND

Industrial Music Is Spur to Production 537
 Practical Audio Amplifier Theory, Part V (Conclusion) by Ted Powell 538
 A Recording Amplifier by Robert J. Nissen 539
 Volume Expander by Harry Newton 548

EXPERIMENTERS

Resonant Coils and Reacting Condensers by Fred Shunaman 540
 Questions and Answers on Crystal Receivers by John Haynes 541

CONSTRUCTION

4-Tube Superregenerator Detects Airplanes by Alex Beatty 542
 The Floating Grid Relay by J. H. Shay 542
 A Midget Oscillator for Code Practice by David Gnessin 543
 A Compact Six-Tube Broadcast Receiver by B. W. Embree 544

BEGINNERS

What You Should Know About Electronics by W. C. White 546
 Phones and Speakers; How Do They Work? 547
 A Simple Test Panel by Albert E. Wilder 548

DEPARTMENTS

RADIO SERVICE DATA SHEET (See Servicing) 532
 Servicing Notes 536
 Question Box 549
 Radio Hookups 552
 The Listening Post 557
 Radio Kinks 558
 Latest Radio Apparatus 560
 Book Reviews 575



Published by Radcraft Publications, Inc. Publication office: 29 Worthington Street, Springfield, Mass. Editorial and Advertising Offices: 25 West Broadway, New York City. Chicago Advertising Office: RADIO-CRAFT, 520 North Michigan Avenue, Chicago, Ill.

RADIO-CRAFT is published monthly, on the first of the month preceding that of date; subscription price is \$2.50 per year in U. S. (In foreign countries, 75c additional per year to cover postage; Canada, 50c additional.) Entered at the post office at Springfield as second-class matter under the act of March 3, 1879. All communications about subscriptions should be addressed to: Radio-Craft, 25 West Broadway, New York, N. Y.

Notice of CHANGE OF ADDRESS should reach us at least one month in advance. Be sure to give your OLD ADDRESS as well as the new, as without the old address we cannot find your name in our files.



Foreign Agents:

London—Gorrings's American News Agency, 9A Green St., Leicester Square, W. C. 2, England.

Melbourne—McGill's Agency, 179 Elizabeth St., Australia.
 Dunedin—James Johnston, Ltd., New Zealand.



Text and illustrations of this magazine are copyright and must not be reproduced without permission of the copyright owners.



Copyright 1943 Radcraft Publications, Inc.

7 Days FREE TRIAL

Costs You Nothing to Examine This Amazing New Three Volume Set of REFERENCE BOOKS OF PRACTICAL



ELECTRICITY

Each Book 8½ x 11 inches. Handsomely Bound in Harvard Red and Gold Leatherette.

AT LAST! A set of electrical books written in clear, understandable language for the "beginner" or "old timer." Solves your everyday electrical problems easily, quickly and thoroughly.

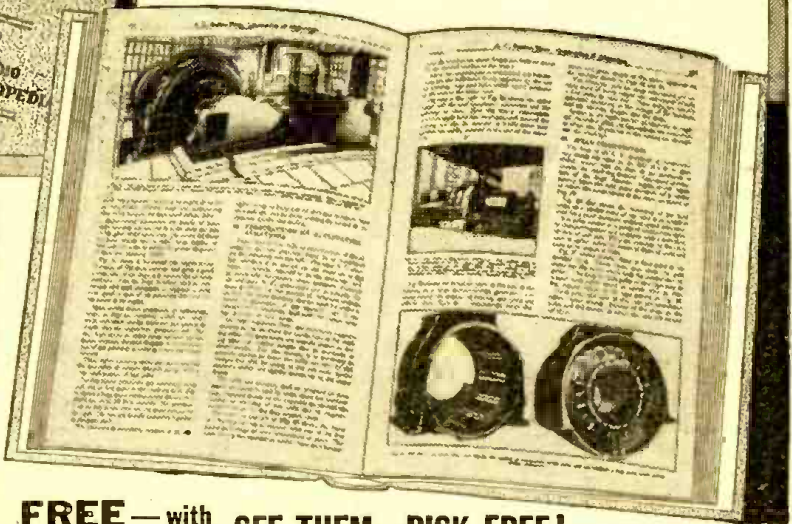
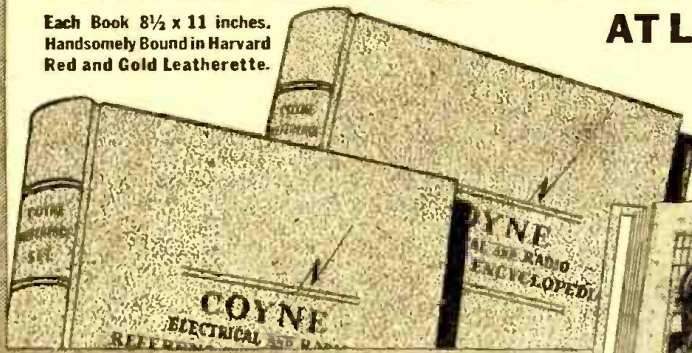

SEND NO MONEY! COUPON BRINGS COMPLETE SET!

Now at last, it's easy, practical to get a knowledge of Electricity at home. Whether you want to learn Electricity or whether you are now doing electrical work, you need these books.

AUTHORITATIVE. PRACTICAL—prepared by experts. Used regularly on the job by hundreds of Electricians, service men, radio men, air cadets, students, maintenance men, etc. **EASY. COMPLETE.** Covers everything Electrical: Armature winding, A.C. and D.C. Motors, generators, electronics, automotive electricity, refrigeration, etc., etc. Answers your electrical questions quickly, clearly, completely. Also includes Radio, Television.

FREE — with Reference Books

Send for these reference books now, and I'll include 1 full year of Technical Service—personal advice by mail on any Electrical or Radio subject.

SEE THEM—RISK FREE!

Don't send a penny. Simply mail coupon below and receive your set. Examine books 7 days, with no obligation. Then, if you decide they are the finest, most practical reference set you ever saw, send \$3, and the same amount monthly until total price of \$12 is paid. I'll prepay all shipping charges. Offer is limited. Mail coupon NOW.

H. C. LEWIS, Pres., COYNE ELECTRICAL SCHOOL
500 So. Paulina St. Dept. 63-T2 Chicago, Ill.

HUNDREDS OF PICTURES AND DIAGRAMS! HUNDREDS OF ELECTRICAL SUBJECTS AT YOUR FINGER TIPS!

A few of the many branches of Electricity explained and pictured in this amazing set are:

- | | | |
|------------------|-----------------|----------------|
| Air Conditioning | Refrigeration | Power Plants |
| Telephony | House Wiring | Diesel Engines |
| Auto Electricity | Electric Signs | Motors |
| Talking Pictures | Home Appliances | Armatures |
| Generators | Switchboards | A.C. and D.C. |

*Complete Ready Reference Index of over 2000 listings tells you instantly where to look up any electrical fact.

H. C. LEWIS, Pres.
COYNE ELECTRICAL SCHOOL
500 S. Paulina St., Dept. 63-T2
Chicago, Ill.

NO RISK COUPON

Send me the big 3-volume Coyne Electrical and Radio Encyclopedia, postpaid. Within 7 days after receiving the books, I'll either return them or send you \$3, and \$3 a month until advertised price of \$12.00 is paid.

NAME
ADDRESS
CITY STATE

OCCUPATION AGE
SAVE 10% Send cash price, \$10.80, with order if preferred—you save \$1.20. Same 7-day free trial and return privilege.

A TECHNICAL
"MUST"

SYLVANIA SERVICEMAN SERVICE

by
FRANK FAX



At the risk of repeating myself, I'm plugging again the new revised Sylvania Technical Manual on Radio Tubes, because it should be a "must" on the bench or in the pocket of everyone interested in radio sales and service. Particularly now, because it has the basic data behind the Correlation for Substitution Chart and the Characteristics Sheet.

One section of this 275-page handbook lists new types of tubes released since issue of the last Manual. There is also a new section on panel lamps. Thus, it is as complete as possible at this time.

A plastic-ring binder allows the book to lie flat and remain open at whatever page is being consulted. Data arrangement remains the same, as do the easy-to-use index tabs.

The new revised Technical Manual still sells for the prewar price of 35 cents. If your jobber is unable to supply you, write to Frank Fax, Dept. RC-6, Sylvania Electric Products Inc., Emporium, Pa.



Complete and reliable technical data on radio tubes—recently revised—price only 35 cents.

SYLVANIA

ELECTRIC PRODUCTS INC.
RADIO DIVISION
Formerly Hygrade Sylvania Corporation

MORE RESEARCH ON RADIMPS

Dear Editor:

I have been studying Dr. Flitternix' system of making Radimps visible. From the meager description of his circuit I finally managed to build up the machine and to do some experimenting with it. At first, results were absolutely nil. However, by close application of the strictest electronic principles I finally discovered several Radimps in the very circuit I was working on. Naturally I drew on my radio service experience and dealt with them quickly. Then just as I turned the machine on and sat down to enjoy the antics of these little fellows a Tubimp went to work, delaying my experiment quite some time. I finally got the machine going and had quite a little success. After viewing every one (I am not boasting either) of the Imps I got to thinking that it might be possible to see many others.

I decided to build a bigger and more powerful machine with which to carry on my experiments. This new machine follows the elementary principles as laid down by Dr. Flitternix but has many new advantages in power, ease of operation and flexibility. Of course I ran onto a great many difficulties due to rationing, scarcity of parts, etc. For instance, in the doctor's method a thin piece of cheese is used for the screen coating. Now my ration book would not allow the use of this high point material. I looked around for some easier-to-obtain material which might give as good or better results. I finally found such a substance which reacts so much better that I was amazed. Of course I immediately turned this discovery over to the army and it is now a military secret. This is the only part that I cannot describe as the rest of the circuit is more or less (mostly the latter) conventional.

One other radical change I made was in the green dill pickles. Green dill pickles in the circuit gives the Imps a sour look but also shades the image with a green tint. I find that green is not their true color. They are not green by any means for they have been in radio longer than you and I. I find them very experienced and proficient in their work. The true color of the Radimp is yellow. Does he not hinder the war effort? I have been well acquainted with a Tubimp for some time and he told me in

strict confidence that none of the Radimps buy war stamps and bonds. I believe that proves beyond dispute that their color is YELLOW. For this reason I used yellow dill pickles in the circuit. This shows him up in his true color.

The circuit I used had a directional Anti-lux pick-up. From this the signal passed to a single Diathermal Relaxitive tube with Reflexographic Electromixer characteristics. Then to the regular perambulator circuit which introduced it to a pair of rectangular pentameters coupled in hush hush. This last coupling was used in order to cut down the high volume of most of their voices and yet amplify the final image on the yellow dill pickles. An evil eye may be hooked up in this circuit if desired and would undoubtedly give a much clearer picture.

With this hookup I had immediate success which proved almost phenomenal. The original Imps were all seen very clearly as well as several new ones which we all know about but have never seen. To date I have seen the following:

SCRATCHIMP—This little imp has fleas and is continually scratching them, making an awful noise in the speaker.

DIAGRIMP—Responsible for misprints in diagrams.

NIXIMP—This one is vile. He is responsible for manufacturers not plainly marking the make and model number on their receivers as well as not color coding and marking part values.

INTERMIMP—Causes intermittents.

I hope there will be other experiments with these circuits. Who knows what might come of this meager start?

PHILIP E. RIMER,
Homer, Ohio.

P. S.:

I am wondering what the "gullible" readers of *Reader's Digest* think of the amount of money from taxes and bonds the Government is spending for all the "Rube Goldberg" devices used in keeping the army radio going. Are these same readers sitting at home looking at their dead receivers and wondering why their favorite "Gyp" repairman can't fix it now that the army has all his "Rube Goldbergs"?

WANTS PICTORIAL DIAGRAMS

Dear Editor:

I would like to make a suggestion about *Radio-Craft* magazine.

I think it would be better to put the plans of the receivers in pictorial diagrams rather than in schematics as you have them. It is easier to read than the other. All the boys around here who buy the magazine say they would make a certain item if it was in pictorial drawing.

They also say that they know the symbols but they still cannot make the set by sche-

matic plans. It is the same way with me.

I thought you would like to know how to make your magazine better.

(No name or address given.)

(Pictorial diagrams are OK for the beginner, sometimes, since they are limited to one-tube receivers. *Radio-Craft* has had several in the past. But in the more complicated drawings a regular diagram is more practicable, and much easier to follow if one takes the trouble to learn the symbols.—Editor.)

POTTRUFF CORRECTION

Dear Editor:

In checking over the drawing of my signal tracer as published in the April issue of *Radio-Craft*, I find there is an error in the value of the plate resistor of the 6K7 tube. This resistor is marked 2400 ohms—it should be 24,000 ohms.

I checked the drawing over several times before sending it to your office, but evi-

dently passed up the mistake each time. One of the "Resistimps" must have been at work.

With the 2400-ohm resistor in the plate lead of the 6K7 there will be practically no amplification.

E. POTTRUFF,
Mission City, B. C.

LIKES MOODY

Dear Editor:

Mr. Petersen—Radio Instructor (ESMWT) Radio Amateur, Radio Serviceman (formerly), Radio Operator, (commercial); and myself—electrical contractor, radio repairman, college student (formerly) and business man (commercial)—see eye to eye regarding Mr. Moody.

Why publishers of a technical magazine—that can be obtained by anyone—allow such articles, when they know that a certain percent of the readers won't be scared out of their wits, and will be directly benefited, is beyond me. Such a thing could go far enough to eliminate the need for radio instructors and increase the electrical mathematical knowledge of the average radioman to a point where he would be sure which way electrons and current flowed.

Here's an example of the possible damage: I know an electrician. He is tops in speed and workmanship, and as a trouble-shooter I have never seen his equal. He

has been going steady at it for 20 years and is always in demand. I have seen a company engineer offer to quit if he couldn't take him along on a trouble job.

One night Superman and I were sitting on some 15 K.V.A. transformers and gossiping. Superman was in a confidential mood, and as the talk drifted around to transformers, he confessed that after all the years, he couldn't understand why a transformer, with its comparatively low resistance, didn't short the line or blow the primary fuse.

About one Moody article a month—mistakes and all—at the beginning would have ruined a darn good electrician, and instead of spending a lifetime with a pair of Klein's in his hand and taking orders, he would long ago have been signing his name with more tag lines than Mr. Petersen.

So let's keep the inside dope to ourselves or "there won't be no more laborers."

EARL RUSSELL,
Colfax, Ill.

AN ESTABLISHED SERVICEMAN

Dear Editor:

Your inquiry about Service Shop photos induced me to send in mine. (The photograph of Mr. Shaffner's shop is reproduced elsewhere in this issue, in connection with the article, "Home Servicing Is Nonsense.")

Like Mr. M. J. Edwards, whose shop photo appeared in the March issue, I do quite a bit of "impossible" servicing, but my big item is simply a lot of radios. Behind the photograph are more than 75 radios "waiting."

Stocks and PARTS are elsewhere!

I service our town of about 7,000 people,

and at least a 30-mile radius, since Uncle Sam has taken our other servicemen.

Have serviced since radios were commercially sold and have read your publications about as long.

I like articles by W. Moody and Ted Powell, also the Mailbag.

JACK SHAFFNER,
Clinton, Mo.

(The photograph on Page 534 shows what apparatus may profitably be used by the active Serviceman, and is one of the best answers to the screw-driver mechanic. —Editor)

A WELL PLANNED SHOP

Dear Editor:

I am submitting a picture of part of my Radio Lab. in challenge to Mr. Edwards' picture as shown in the March issue.

I have what he has not—plenty of daylight—as the dark space over the bench is a large plate window facing south, also on both ends of bench (not shown) are two large windows.

The work bench is sixteen feet long and the whole lab. is sixteen feet square. The Chanalyst at left and the other pieces of equipment below it are on a movable stand.

Any other information you may require will be furnished on request.

J. LEO PHELAN,
Waterbury, Conn.



NOW!
SPRAYBERRY
RADIO
TRAINING
PAYS OFF 3 WAYS

TRAIN IN SPARE TIME AT HOME OR AT CAMP...

The greatest OPPORTUNITY that ever existed in Radio is open to you RIGHT NOW! Don't miss it! My practical Home Training will fit you quickly for a profitable Radio Repair business of your own... OR for a good-paying job in one of the Nation's Radio plants at work on equipment for planes, tanks, ships, etc. OR for higher rating and better pay if you enter the Army, Navy or Marines.

NO PREVIOUS EXPERIENCE NEEDED

Sprayberry Training starts right at the beginning of Radio. You can't get lost. My tested and proved methods will get each subject across to you in simple, understandable style. Your success is my full responsibility. You learn Aviation Radio, Radio Set Repair and Installation Work, Mobile Radio (Auto-Tank), Television, Frequency Modulation, Signal Tracing, etc. You will be prepared to cash in on the coming great era of Electronics and Electronic equipment.



READ WHAT GRADUATE SAYS
"Salary Has Increased"

"Since I have finished your Radio training I had to enlarge my laboratory with additional equipment, as I have all the Radio repair work that I can handle. My salary has increased to 50 to 75 dollars a week. I install transmitter equipment and public addressing systems. Money can not buy the training that I received through your Academy." Asa Smith, Post Box 528, Ft. Leavenworth, Kansas.

EARN WHILE YOU LEARN

Along with your Training, you will receive my famous Business Builders which can bring you in a nice profit shortly after you begin my Course. No matter if you remain a civilian or enter military service, my Radio Training will give you the background and knowledge to cash in on the marvelous future that lies ahead.

EASY TO START

Remember it is not necessary for a Sprayberry student to have any previous experience in the field of Radio. You can master the Course in your spare time. It will not interfere in any way with your present duties.

GET THE FACTS ABOUT MY TRAINING—NOW! TAKE THE FIRST IMPORTANT STEP TOWARD THE MONEY-MAKING FUTURE OF YOUR DREAMS. ALL FEATURES ARE FULLY EXPLAINED IN MY BIG, ILLUSTRATED FREE BOOK. WRITE FOR IT AT ONCE.



RUSH THIS COUPON FREE
for BIG FREE BOOK

DON'T DELAY! ACT NOW!

SPRAYBERRY ACADEMY OF RADIO
F. L. SPRAYBERRY, Pres.
620-F University Place, N. W., Washington, D. C.

Please send me FREE copy of "HOW TO MAKE MONEY IN RADIO."

Name..... Age.....

Address.....

City..... State.....

Tear off this coupon, mail in envelope or paste on penny postcard.



Echophone Model EC-1

6 tubes, 3 bands. Tunes from 550 kc. to 30 mc. Beat frequency oscillator. Bandsread logging scale. Self-contained speaker. Electrical bandsread on all bands. AC/DC. 115-125 volts. ECHOPHONE RADIO CO., 201 EAST 26TH ST., CHICAGO, ILLINOIS

PVT. KILDAY
CAMP LEE

RADIO-CRAFT

Incorporating

RADIO & TELEVISION

“RADIO'S GREATEST MAGAZINE”

. . . Great, as well as unbelievably new radio developments are coming right after the war . . .

POST-WAR RADIO DEVELOPMENTS

By the Editor — HUGO GERNSBACK

It is a well-known fact that technical developments were greatly intensified during every modern war in the past. Radio, which was in its infancy during the first World War, took a tremendous upsurge. The World War really had been a testing ground when radio still was in its swaddling clothes. The vacuum tube had its greatest development during this first World War and shortly after the war broadcasting started.

The second World War is no exception to this rule—radio, as well as electronics, has already seen a terrific upswing during the present war, so much so that we will have a number of truly unbelievable radio and electronic developments, which are already in use now—but which for military reasons cannot be disclosed at the present time.

The following gives only the barest outline of a few new developments which will come right after peace has been declared.

PLASTIC RADIO TUBES. So far radio tubes have been made only in two different envelopes: (1) glass, (2) metal. After the war, we will have a new one, particularly for miniature tubes which give off very little heat and which will be used on battery-operated portable small radios. I refer to plastic transparent tubes. There are a number of special plastics which lend themselves especially to this purpose. This will revolutionize radio tube-making because the tubes can be made even faster than metal tubes, with no heat being used, as is necessitated in glass tube-making. Plastic tubes will be practically unbreakable and will be much cheaper to make than even glass tubes.

ALARM CLOCK RADIOS. Another new development—and a necessity—will be a combination alarm clock and radio, less than six inches in diameter. This will be electrically operated and will have a simplified clockwork which can be set for any time during the 24 hours. The alarm then goes off, the same as any electrical alarm, but instead of ringing, the radio will wake you up by music or your favorite program. Being made in mass production, the alarm clock radio will not cost much more than a first-class electric alarm did in the past.

POCKET RADIOS. The smallest pre-war portable radio could not be called a pocket radio because it probably could not go into your overcoat pocket. But there is a very huge and real demand for a pocket radio, which can be slipped conveniently into your suit pocket. It will be possible right after the war to manu-

facture a two- or three-tube pocket radio set with sufficient power to work a special loud speaker sufficiently loud to get good reception. We now have much smaller specialized radio tubes, and smaller and better batteries. There are also other simplifications, such as smaller variable condensers, and a number of other new gadgets making a very small pocket radio possible. Such receivers will also sell at a low cost, probably below \$10.00. There is a huge market for such pocket sets.

KLYSTRON MARVELS. The Klystron, possibly the greatest radio invention since the Audion in 1906, was developed by American inventors several years before Pearl Harbor. Its greatest use before the war was as a new blind landing system for airplanes, a system far better than anything that had been used before. The Klystron is at present used for many highly important and secret war devices which it is not possible to disclose at the present time.

Yet the Klystron will completely revolutionize almost every phase of radio communication for peacetime uses. It is one of the most remarkable radio-electronic devices imaginable. The waves produced by the Klystron are totally different from any ever known before. They are centimeter waves—much shorter than any radio waves used heretofore, which alone makes it possible for the Klystron to use about *one-half million different* wave channels. This is a tremendous number of separate channels when you realize that there are only about 100 different channels in the standard 200 to 450 meter broadcast band! Compare this with the half-million separate channels and you will appreciate the real importance of the Klystron.

Unfortunately, due to war restrictions, it is not possible here to state all of the many hundreds of different uses that the Klystron has, and it would take many pages to even give an outline of what the Klystron is capable of achieving in the future.

The Klystron, however, will certainly be used in connection with television and in personal radio telephone networks. It is possible for the Klystron, for instance, even today to bring to life a separate telephone network, whereby you may have a pocket telephone set on which you can be called no matter where you are at any time during the day or during the night. All this may sound fantastic now, but it already can be said to be an accomplished fact.

A Digest of News Events of Interest to the Radio Craftsman



"STRATO" TEST CHAMBER FROM BOMBER NOSE

A new simple altitude test chamber for aircraft radio and electronic equipment, in which engineers can now for the first time see the entire apparatus in operation under conditions duplicating the stratosphere seven and one-half miles up, was announced last month by the RCA Victor Division of the Radio Corporation of America.

Built of transparent Plexiglas, the chamber is actually the unfinished nose of a famous American bombing plane. Because of the transparent construction, it makes possible the complete testing and inspection of any piece of radio apparatus by several engineers at one time and materially speeds test work.

In the past, parts or instruments were tested individually under laboratory conditions for their reaction under flight pressures and temperatures. This was a time-consuming process. The chamber shown here makes it possible to check a complete assembly, and to read a number of meters connected to different parts, at the same time, in sharp contrast to the old and laborious process.

Defects in design, which normally would remain hidden until actual high altitude flights could be made, are now spotted at a glance. An entire complement of test instruments and meters may be connected to the apparatus under test and plainly viewed by the project engineers. At seven and one-half miles up, many things can happen to aircraft radio and electronic equipment, since apparatus of this type incorporates many precise mechanisms. Low temperatures and pressures bring about changes in

This stratosphere traveller stays on the ground. Furthermore, the stratosphere is inside it instead of outside. With these minor differences, it is an ordinary bomber nose. The line through which air is withdrawn to approximate stratosphere conditions can be seen to left of center. The hook at the top of the picture is used to lift the nose clear when removing or replacing apparatus.

these delicate mechanisms which may cause current leakage, disabling electrical discharges, known among engineers as "flash-overs," and other failures which normally will not occur at normal altitudes.

This chamber is cone-shaped, about four feet high and five feet in diameter at its base. It is just less than one-inch thick and capable of withstanding tremendous shocks and pressures. Normally, before assembly on its bombing plane, holes are bored for the business ends of machine guns and heavier weapons. In the stratosphere test chamber, the holes are omitted, thus enabling the engineers to make it air tight. An air tight seal is accomplished by fitting a heavy platform, arranged for mounting radio apparatus under test, with a ring of soft rubber. The test chamber cone is then lowered until its base rests on the rubber ring. As the air is withdrawn by a powerful suction pump, the atmospheric pressure on the outside of the chamber forces it down into the rubber ring and creates a perfect air seal.

Test chambers previously in use were constructed of metal with heavy glass windows serving as portholes. Lack of adequate visibility through these portholes frequently required shifting and re-mounting the apparatus under test to permit complete observation of results and each shift in mounting called for repeating the simulated altitude run to stratospheric pressures. Now by means of the new all-plastic chamber these tests are made in a single operation. Thus this bomber nose keeps other bombers flying with equipment that functions despite the altitude or temperature.

F.C.C. RELAXES RULES ON FM

A realistic reaction to wartime technical difficulties and manpower shortages was announced last month by the F.C.C. in its suspension of Sections 3,229 and 3,261 of its Regulations. Suspension is temporary, but is expected to run for the duration of the war. Section 3,229:

"Provided that within one year of the date of first regular operation of a high frequency broadcast station, continuous field intensity records along several radials shall be submitted to the Commission, which will establish the actual field contours, and from which operating constants required to deliver service to the area specified in the license are determined. The Commission may grant extensions of time upon showing of reasonable need therefor."

The purpose of the above was to provide an experimental check of the actual service area for comparison with the predicted area at the time of license issuance.

Section 3,261 required that FM broadcast stations maintain a regular daily except Sunday schedule of at least 3 hours before 6 P.M. and at least 3 hours between 6 P.M. and midnight, local standard time. The rule also required that FM stations broadcast during each of the scheduled day and night periods at least one hour's program service not duplicated simultaneously in the same area by a standard broadcast station or another FM station.

STUDIO TO TRANSMITTER RADIO RELAY ANTENNA

A new radio relay antenna for studio-to-transmitter service was developed last month by engineers of the General Electric Electronics Department at Schenectady, N. Y. It is designed for relaying FM programs from studio to the main transmitter via any one of the 23 assigned channels centering on 337 megacycles. One of the new antennas is in operation at Schenectady where it is installed atop a building to relay programs of FM station W85A, with studios in the building, to the station's main transmitter in the Helderberg Mountains, 12 miles away.

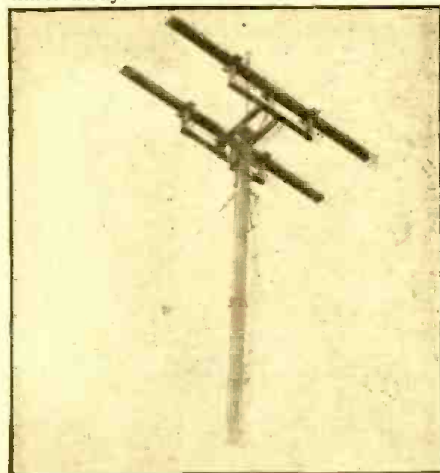

The antenna concentrates its radiation in a narrow beam in the desired direction only, in accordance with well defined and narrow limitations of the Federal Communications Commission. The antenna consists essentially of five sets of simple dipole antennas, properly mounted and connected electrically in a manner to achieve the necessary radiation pattern. The entire electrical system is mounted within a non-metallic housing which protects it from rain, snow and ice. It is made to mount easily on a single metal pole.

PRODUCTION STEP-UP IN RADIO BATTERIES

A sharp increase in the production of radio batteries, approaching a goal of 425,000 batteries monthly, was announced last month by the War Production Board. Arrangements are being made to have sufficient zinc—which is the most critical item entering into battery production—allotted for this program.

Bitter complaints from rural areas were the spur which put the Board into action. Farmers have been pointing out through their representatives in Congress that radio is of vital importance on the farm front. Whereas the city listener depends on his receiver solely as a source of entertainment, the farmer listens for essential crop and market reports and weather information. A radio in working condition saves time which may be used to produce the food that must win the war.

The influence of radio as a builder of morale is greatest in the rural districts. Unhampered by the competition of the movies and other urban distractions, it always has an audience. In many districts the radio is the sole source of current news. These things give rural radio an importance not shared by urban receivers.

A production rate of 425,000 batteries per month will not be sufficient to satisfy the requirements of all farm radio owners, since use of the radio by farmers has increased greatly since the start of the war. It will, however, permit listening for vital purposes for nearly all farmers, although it will still be necessary that they try in many ways to conserve the drain on batteries. It has been estimated that if the batteries were available, farmers would use more than six million per year, while the rate of 425,000 monthly will provide only 5,100,000.

SERVICEMEN WIN PRIZES IN REPLACEMENT CONTEST

War Bonds to the amount of \$100 each were won last month by James Rapp, Freeport, N. Y., Wilbur Pelham, New Harmony, Ind., Pat Schultz, North Hollywood, Cal., Carl Concelman, Brielle, N. J., and Ray Pentecost, Chicago, Ill. They were the victors in International Resistance Company's "Here's How" volume control replacement contest.

The contest asked servicemen to suggest ways and means of keeping home radio sets functioning satisfactorily when volume control trouble developed and the replacement unit which would normally have been used to correct the situation was not obtainable. Both mechanical and circuit changes were eligible and replies were divided between these two classifications.

Mechanical repairs suggested fell mainly in the category of using the old shaft and adapting it through the use of specially devised couplings. Another group in this classification appeared to make out well by making use of parts from old controls in their stocks.

Electrical repairs were made chiefly by changing the original circuits. In one case, a cathode-antenna volume control circuit instead of the screen-grid and aerial circuit originally used in the set made possible the replacement by a single unit of an unobtainable dual volume-control. Other ideas consisted of such changes as using fixed tone-compensation circuits with suitably tapped volume controls, instead of those in which an independent section of a dual control varied tone compensation.

RADIO SEWING MACHINE "WELDS" PLASTIC FABRICS

A radio sewing machine was announced last month by RCA laboratories at Princeton, N. J. This new device has promises of becoming one of the new radio-electronic machines of the post-war period, when expansion of its use may be ex-

itself, the radio sewing machine eliminates these difficulties. This is what happens. The material to be sealed, or "sewed," is fed across a table top through two small roller wheels which serve as the "needle." The wheels have two functions, the first

being to pull the material along. At the same time, they act as plates which set up a small electro-magnetic field of radio-frequency current. As this current passes through the material, heat is generated by dielectric loss, or, in other words, by the struggle of the current to get through the closely packed molecules of matter which compose the material. The heat causes thermoplastics to fuse, or weld, in a tight bond.

Somewhat similar in appearance and operation to the conventional sewing machine, the radio device derives its current from a low-power radio - electronic oscillator. A small electric motor drives the roller wheels. Controls are in a foot pedal. Ordinary alternating current of 110 volts supplies the power.

Laboratory tests have revealed the radio machine as an effective instrument for the handling of such thermoplastics as vinylite, koroseal,

and ploidfilm. All three of these materials are being used in practical applications.

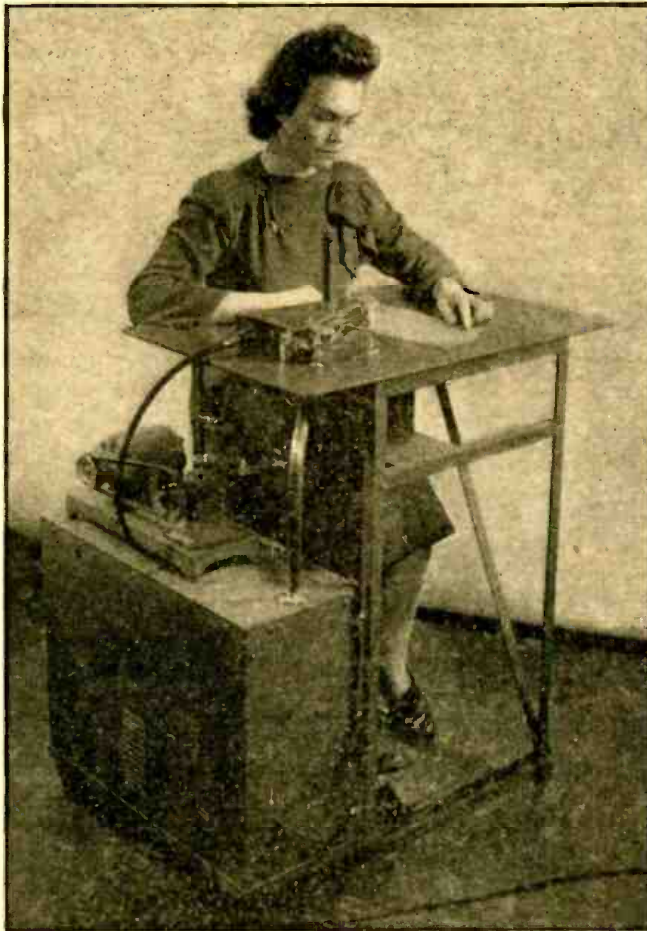

tended through wartime developments.

Instead of needle and thread, this machine uses radio-frequency current; instead of woven cloth, it works on thermoplastics—the new synthetic materials that are finding wide application in the making of rain-coats and caps, weather balloons, and in the packaging of many types of food and oils.

It "stitches" a thin solid seam that is air and water tight, creating a bond that is stronger than the material itself. It does this simply and easily, thus promising to overcome many fabrication difficulties involved in conventional processing methods as applied to thermoplastics.

The radio sewing machine was created to meet a definite need in the plastics industry. Thermoplastics, tough resilient material, can be rolled into large cloth-like sheets, which makes them highly useful in any number of ways. When cut into patterns, the sections are usually put together by sewing with thread, by cementing, or by fusing with externally applied heat. None of these methods has been found to be entirely satisfactory for mass production.

Fusing by heat appears to be the most desirable method, but there are problems of maintaining uniform temperature, also of processing equipment getting gummy and sticky.

By generating heat inside the material

NEW PLASTIC RESISTS HEAT

A new formulation of "Lucite" molding powder to make plastic articles which will withstand much higher temperatures than those made from any commercial thermoplastic powder, was announced by Dr. Kuetzel of Du Pont, in an address before the Society of the Plastics Industry last month. This high heat-resistant "Lucite" is a war development of Du Pont.

Articles molded from the new powder do not soften appreciably or distort when exposed to a temperature of 212 degrees F., the temperature of boiling water. This is 30 to 40 degrees above the useful temperatures for similar articles made from other commercial thermoplastic molding powders.

The new formula has roughly the same electrical and mechanical qualities as general-purpose "Lucite." Articles made from it are crystal-clear, or the powder may be dyed or pigmented to desired colors. General-purpose powders will continue in molded articles where high heat resistance is not required. Both are under allocation for war uses.

POPULAR ELECTRONICS*

By RAYMOND F. YATES

PART V

THE whole new science of electronics is built up on the fact that the electron—negative unit of electricity—can be guided about and controlled very readily. This applies to direction, speed and concentration. Being electrically negative, all

mentally speaking they ARE VOLTAGE. The higher the potential or voltage, the greater the electrostatic fields. On the other hand, the greater the electrostatic fields, the higher the speeds of ions and electrons brought into them under the most favorable conditions.

and that any large and really closely packed aggregation would be improbable. They would reach a point where a "space charge" would accumulate about the filament and other electrons would be repelled back in the direction from whence they came. Those forming the space charge

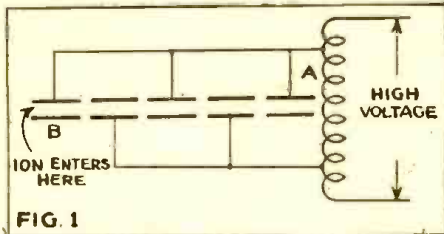

AN ELECTRON ACCELERATOR

Back in 1929, Wideröe, a German investigator, devised a purely electrostatic mechanism for the acceleration of (in his case) potassium ions (we remember that ions are charged atoms). The device is shown in Fig. 1. Here we find a series of cylindrical metal electrodes connected to a high-frequency current with a source at A. Knowing that the voltage of an alternating current is never stationary but rises and falls with the frequency, it will be seen that one segment of the cylindrical electrodes would have a zero voltage while the next segment would have a much higher or perhaps a peak voltage. Therefore ions introduced at B would tend to move through the electrodes reaching higher and higher speeds as they moved along. Naturally, the air would have to be removed from the electrodes.

electrons are sensitive to electrostatic fields. We find them attracted to positively charged bodies and repelled by negatively charged bodies.

Electrons are also affected by magnetic fields. Electronic devices therefore may exercise control over electron masses or streams either by the electrostatic or the electro-magnetic method. Of course, it must be understood that electrons in motion (electric current) generate magnetic fields so it is not strange to us that the lone electron in motion, even when impelled across an evacuated space, can be made to respond by means of a magnetic field of sufficient power. Indeed, it must also be recalled that all of the particles of matter are in some measure either affected by magnetic or electrostatic fields or both. Electronics is no longer simply related to the electron. It deals with all charged particles.

Electrostatic fields can be generated with electric potential or voltage. Indeed, funda-

Magnetic fields tend to bend or curve the path of moving electrons or ions, as will be seen by reference to Fig. 2. Here a cathode ray tube is provided with an outside spiral wire or conductor through which a relatively heavy current (DC) is passed. Under these conditions the electron stream will tend to corkscrew its way down the tube and various effects may be had by compressing or expanding the outside spiral of wire.

More concentrated magnetic fields produce sharper or more acute bending, as will be seen in Fig. 3, where a powerful electromagnet has been brought close to a cathode ray tube. Here the electron stream is abruptly bent back on itself. Herein lies the secret of the fabulous cyclotron, and other interesting and fruitful electronic devices that we shall have to leave for future consideration.

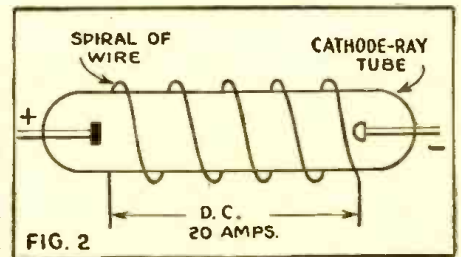

would remain at a relatively great distance from each other and there is perhaps no force in the world that could bring them into close, permanent contact.

If a positive charge is placed on the metal plate of our vacuum tube, an entirely new condition is brought about. It would follow that this charge would tend to draw the free electrons forming the space charge

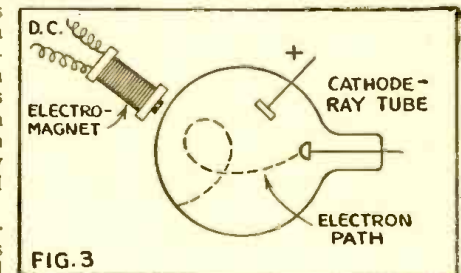

away and if the charge (supplied as we see by connecting the plate to the positive pole of a battery) is sufficiently great (say from 40 to 150 volts) the space charge will be reduced and a constant stream of electrons will move plate-ward. It might be, however, that an increase in the current through the heated filament would produce so many more electrons that the positive charge on the plate would not be great enough to pull a sufficiently large number away and another heavy space charge would accumulate. Thus, it will be seen that there is a relationship between the size, temperature and nature of the filament and the voltage on the positive plate. Distance and the degree of the vacuum in the tube are also important variables.

For a given anode (plate) voltage and

THE RADIO VACUUM TUBE

To keep our assembled facts in an orderly march, it will be well at this time to enter an elementary study of the ordinary vacuum tube.

In Fig. 4 we see what is known as a two-element tube or diode. It has—mounted in a highly evacuated space—a filament and what is known as a plate. It is also noted that, as in the case of the ordinary electric light, current to heat the filament to incandescence is supplied through the wall of glass from an outside source. This may be a battery or, in the case of the alternating current tubes, a transformer with suitable secondary voltage and current.

When metals are heated to a high point, especially in a vacuum, some of the more loosely attached electrons will become so highly agitated that they leap free of the heated surface of the metal with which they have been associated. If no other influence were present, we would expect to find them clustered about the filament of such a tube as we have been discussing. However, it must be recalled that electrons are nega-

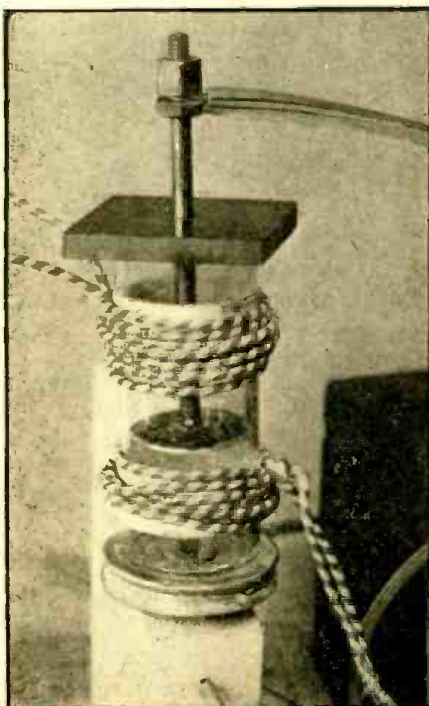
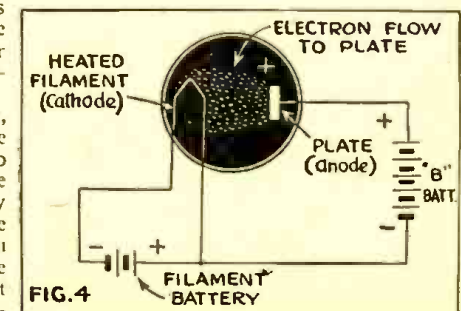

Apparatus for bending cathode rays.

cathode temperature, there is always a definite electron flow in a diode. As we see by means of the simple curve in Fig. 5, a point of saturation is reached.

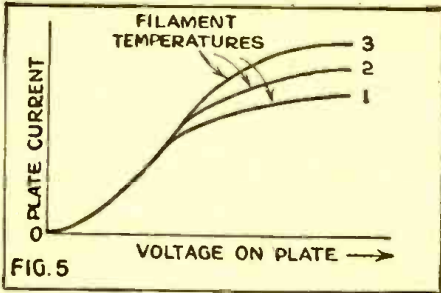

If the plate of the diode is made negative instead of positive, a milliammeter placed in the plate circuit will show a zero reading. No current flows. What, now, would happen if an alternating current were impressed upon the tube? We know that such current changes direction periodically and that impulses are first positive and then negative. As might be expected, only 1/2 of an alternating current succeeds in passing through a diode. The output of

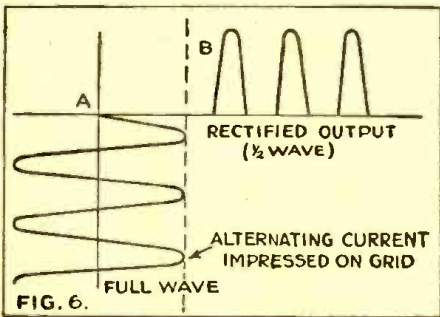

the tube, in place of having a wave form as in Fig. 6 A, has a chopped-off form as in B. This is a pulsating direct current with spaced intervals in which no current flows at all. These intervals represent the other half of the A.C. wave form, which was eliminated. Such a diode would be called a half-wave rectifier. Two of them could be connected as in Fig. 7 to make a full-wave rectifier, each handling half of the A.C. current. Also a two-diode effect could be had in a single envelope, as illustrated in Fig. 8. Such tubes are called full-wave rectifiers.

Dr. Lee de Forest made a major contribution to radio and electronics years ago when he inserted in the diode a controlling element called a grid. This was placed between the plate (anode) and filament (cathode) as shown in Fig. 9 and was nothing more or less than a small piece of wire bent into appropriate form.

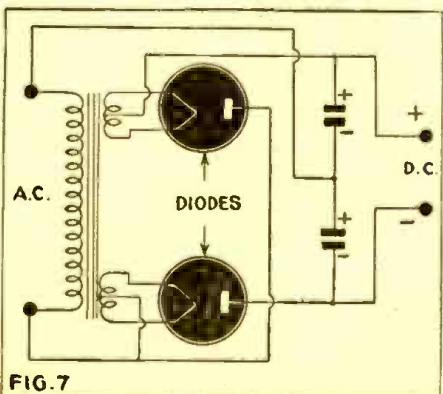

In a sense, this grid functions as a "valve" between the plate (anode) and the filament (cathode). When the grid is negative, it repels electrons and tends to push them back to the cathode. Reduction in the negative charge brings increased flow of electrons and a corresponding increase in the plate current.

As will be seen from the diagram (Fig. 9) three element tubes (especially in radio) are used with a "C" battery, the negative pole of which is connected to the grid. Of course, a too heavy grid charge (negative) will cut off all of the plate current. On the other hand, a positive charge of sufficient strength will dispel the space charge and cause a heavy increase in the plate current. We can understand this from Fig. 10. The grid makes the vacuum tube an extremely sensitive device.

So far, we have considered the diode and the triode; two and three element tubes. Now we shall move on to more complicated devices but first let us recall that electric condensers are formed when two conductors (such as the plate and grid or the grid and filament) are separated from each other and with an intervening non-conductor. At the high frequencies used in radio, it was found that this "inter-electrode capacity" in vacuum tubes greatly interfered with their most efficient use. Condensers can serve as coupling mediums between circuits and the tiny condenser effects within the tubes are doing just that.

In setting out to remedy such situations, and in place of neutralizing this capacity through the medium of a so-called bridge circuit, engineers devised a tube that had no such trouble under RF (radio-frequency) conditions.

This tube was called a tetrode and is shown diagrammatically in Fig. 11. Here a fourth element is introduced called a screen and it is the function of this screen to serve as an electrostatic shield between

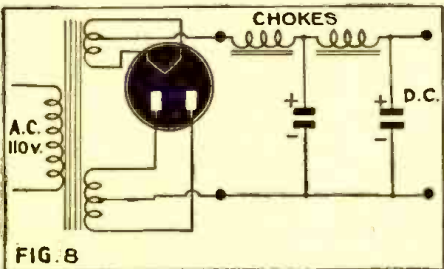

the plate and the grid. These devices are called screened-grid tubes. Although such screens do not entirely eliminate grid-to-plate capacity, they reduce it to a point where it causes very little trouble.

It has been known for a number of years that high speed electrons, upon striking metallic surfaces, knock other electrons loose with such force that what is known as "secondary emission" takes place. The effect was very noticeable in vacuum tubes employed for radio. The electrons leaving the filament and drawn to the plate would reach such high speeds that they would succeed in tearing otherwise

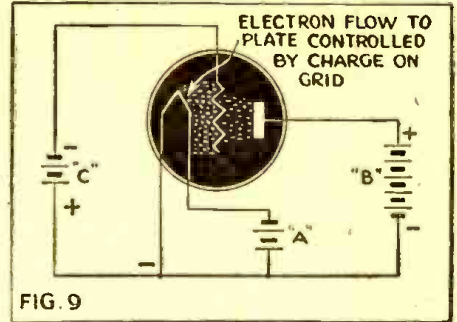

dormant electrons away from the plate surface. Thus tubes were called upon to contend with hordes of wandering electrons. This was not a problem in the old three-element tubes because the highly positive plate soon succeeded in recalling and holding all electrons that had been forced to leave. With the tetrodes or screened-grid tubes, however, matters were not quite so easy. The screen in such tubes was often more positive than the plate, due to plate voltage variations caused by the radio signals.

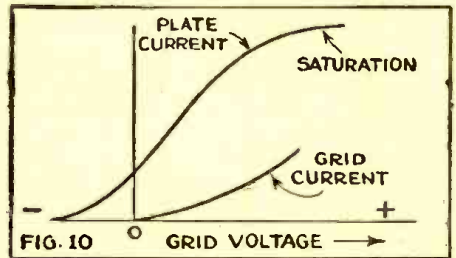

The pentode or five-element tube shown in Fig. 12 solved the problem thus posed. The fifth electrode was very much like the screen grid previously mentioned, save that because of its peculiar function, it was called a suppressor. It was placed between the grid screen and the plate and made negative in respect to both.

Electrons coming from the cathode, and accelerated to great speeds by the electric field in the tube, passed easily through this suppressor-grid to reach the plate, but secondary electrons knocked loose by them and not having reached high speeds were repelled by it back again to the plate from which they had come.

Still another type of radio tube, called the pentagrid converter, is shown diagrammatically in Fig. 13. This is one of what are known as multi-use tubes. These may be described as two tubes mounted in a

(Continued on page 573)



The equipment described in Fig. 15.

ELECTRON MOTOR DRIVE WITH 20-1 SPEED RANGE

By T. R. LAWSON*

AN adjustable-speed electronic motor drive has been developed that can be used in any industry on applications that require constant preset speed at varying loads over a 20 to 1 speed range and smooth, automatic acceleration and deceleration. Flexibility of a direct-current motor drive with an alternating-current supply is obtained, as the incoming A.C.

continued ever since alternating current itself was first commercially used. Many solutions have been offered with some degree of success, for instance, numerous mechanical drives using a constant speed A.C. motor and variable speed output shaft, modifications of the wound-rotor induction motor and slip clutch arrangements. Some industrial machinery is supplied by a separate source of D.C. power, even if it means individual A.C., D.C. motor-generator sets, so that a direct-current motor with its desirable characteristics might be used.

None of the special adjustable-speed, alternating-current drives for general purpose use are without some undesirable feature, whether it be speed range obtainable, speed torque characteristics, first cost, maintenance or mounting difficulties. In many instances where direct-current power is available, the standard direct-current motor does not completely fulfill all requirements; such as, extremely wide stable speed range, good speed regulation and smoother automatic acceleration.

This electronic motor drive, known as the Mot-O-Trol, was designed to fulfill the desired requirements of an A.C. adjustable-speed motor. The basic idea is not new. Such motor drives have been furnished on special applications for some years, but recent refinements eliminate many of the earlier handicaps and make the new electronic system comparable or better than other existing solutions.

Thyratron tubes supply a shunt-wound D.C. motor with rectified A.C. power. In general, the system consists of a single or polyphase grid controlled, thyratron tube rectifier, that takes power from an A.C. line and rectifies it into direct-current output. The rectified D.C. voltage is applied to a regular shunt-wound, D.C. motor and may be varied from zero to motor rated voltage (or above) for D.C. armature control. Smaller thyratron tubes used in the control provide rectified D.C. field current for the motor. The field voltage is held constant throughout the range of armature voltage and then is reduced to provide greater speed range by field weakening above the base speed of the motor.

This electronic control, shown schematically in Figures 1 and 2, for motors 1 h.p. and smaller, uses single-phase, full-wave rectification on both field and armature. For motors of larger horsepower rating a two-phase half-wave rectifier may be used, depending upon the most economical application of tubes. Four pieces of equipment are involved. These are the power transformer, the electronic control, the control station and the D.C. motor.

When mercury-vapor tubes are used, an initial five minute time delay period is required for tube warm-up. However, this time delay need occur only once after the line switch is closed. The control is designed to maintain continuous heating of the tubes at all times, even when the motor is stopped, unless the line switch is opened or the low-voltage protection fea-

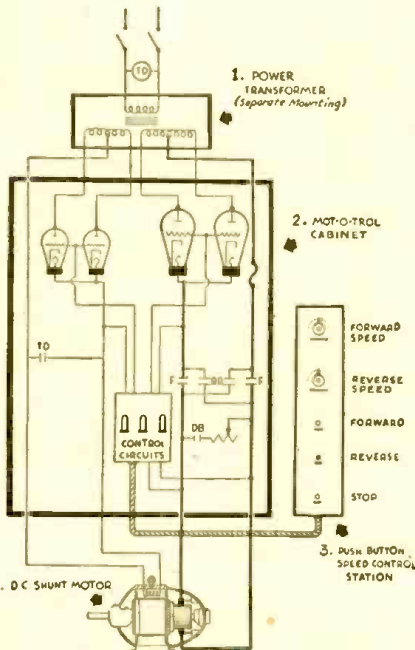

Fig. 1.—Schematic of apparatus shown in the photograph.

power is converted by grid-controlled rectifier tubes and supplied to the armature and field of the D.C. motor. This electronic drive provides constant torque for all speeds up to the base speed of the motor and constant horsepower above base speed.

The search for a satisfactory motor with exceptionally wide adjustable-speed range to operate from alternating current has

*T. R. Lawson, Application Engineer, Electronic Section, Westinghouse Electric and Manufacturing Company.

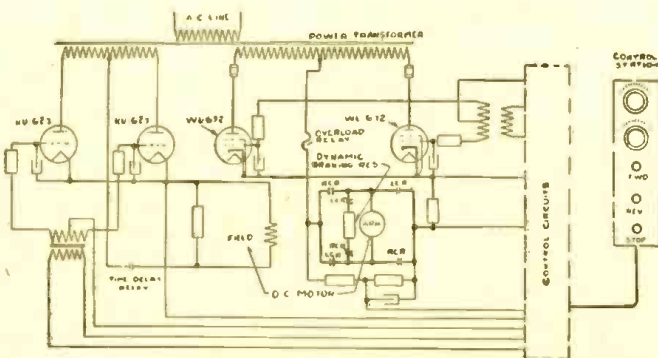

Fig. 2.—Mot-O-Trol Power Circuit.

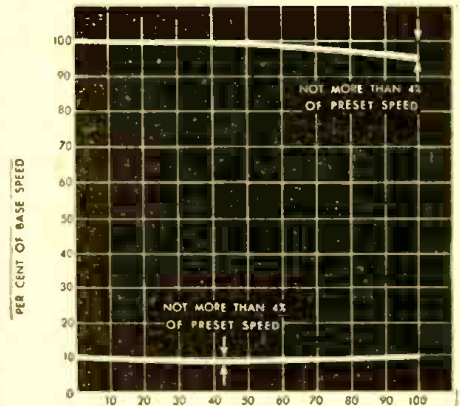
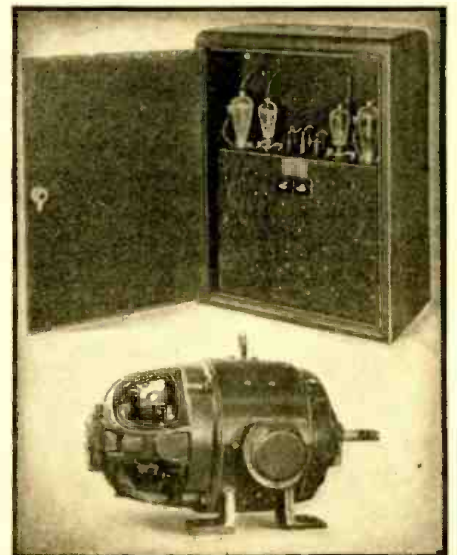

Fig. 3.—Speed control at 10% and 100% of base speed varies not more than 4%.

ture operates. The time delay relay contacts are in the field control and armature control circuits so that the "forward" and "reverse" push buttons are not effective until the initial warm-up period is over.

Speeds may be preset, within the design range. With two speed-control potentiometers and reversing contactors, different forward and reverse speeds may be



preset so that only the operation of the forward or reverse push buttons is necessary to obtain a predetermined speed in either direction. Speed adjustment may be made at any time while the motor is running. Speed control potentiometers are tandem type to cover the entire range of
(Continued on page 573)

MICRO-WAVES

Future progress in radio lies in the direction of those areas of the ultra- and super-high waves. Advances in these ranges are limited only by human ingenuity, which is daily devising new techniques for penetrating this great field. The article below details some of the latest techniques and problems of the micro-wave field.

THOSE frequencies whose wavelengths lie in the fraction of a centimeter region, are fast becoming workable tools to the communications engineer, according to Dr. George C. Southworth in his recent address before the joint meeting of the Institute of Radio Engineers and the American Institute of Electrical Engineers. Future progress in television and communications will be greatly helped by the wider channels available with micro-waves. Also smaller antennas, with their highly directive properties, approaching the straight-line paths of light, will be available, and interference reduced.

IMPORTANCE OF TRANSMISSION LINES

Research must be done on transmission lines, since the ordinary insulating materials fail in the micro-wave region, due to leakage, radiation, stray capacitance, inductance. Thus the problem of conducting waves from generator to antenna, and from antenna to receiver, assumes an importance unknown in the long-waves of the broadcast band and lower frequencies. Ordinary insulated wire is useless here, and even the special transmission methods used for short waves may become hopelessly inefficient.

The co-axial line, in which one conductor is a hollow tube, and the other conductor a thin wire supported centrally inside it, has been one of the best answers to this problem. One of the peculiarities of the micro-waves is that if the central conductor is completely removed, it is still possible to transmit energy through the tube (the outer conductor). In this case, it becomes a wave guide.

CONDUCTION ALONG AN INSULATOR

More strangely, if the tube be filled with insulating material, even the outer conductor can be removed. The waves then travel along an insulator.

This incredible effect is due to the difference in the dielectric factor of the insulating matter composing the tube and of the other insulator (the air), surrounding it.

The co-axial line and the conducting tube (or wave guide) are the developments showing greatest promise. Of these two, the wave guide appears to be the more desirable at micro-wavelengths. At lower frequencies, the co-axial conductor shows lower attenuation losses, but in what is now the more important micro-wave region the wave guide has decided advantages, which it maintains down to a critical frequency (about 3×10^9). Below that point, it cuts off abruptly.

RADIATORS FOR SUPER-HIGH WAVES

To radiate the micro-waves, all that is necessary is to flare the guide out in the form of a horn, and the waves act much as would sound waves in a similar conductor.

A wave guide may also be made into a cavity resonator by blocking one end of the chamber with a metal plate, and closing the other partially with a plate with one hole in it. By varying the length, it can be tuned to the exact frequency desired, the operation again being analogous to the action of acoustic instruments. With a small hole, if the chamber be $1/2$, $2/2$ or $3/2$ wavelength long, it will admit energy readily; if $1/4$, $3/4$ or $5/4$ wavelengths, it will repel energy, or in other words, be anti-resonant. Since the wave pattern in a resonator is fixed, it is possible to locate a detector at precisely the right spot in the pattern to obtain maximum response.

SOUND AND MICRO-WAVE PARALLELS

Although these short waves show some striking analogies to sound waves, there are important differences as well. They can be guided down a tube, radiated from a horn, or resonated in a chamber; tube, horn, and chamber being identical with similar apparatus used for sound waves. However, any hole in a tube will let out some sound

energy. One of the most useful forms of the electric wave, on the other hand, can be so oriented to a hole in the tube, or even a long slot, so that no energy escapes. Hence it is possible to insert an electric probe and explore the electrical conditions in various parts of the tube.

PRACTICAL FREQUENCIES FOR GUIDES

The wavelength at which it becomes advisable to use the wave guide technique is in the order of one foot—frequencies higher than about a billion cycles per second. At lower frequencies conventional two-conductor systems (co-axial tubing for example) has advantages over the just-described types of apparatus, which rapidly become bulky and uneconomical.

The new types of apparatus seem at their best in the centimeter wavelength range. For still shorter waves, it may be that the limiting factor will be the ability to manufacture parts sufficiently small. No predictions can be made as to future development or technique.

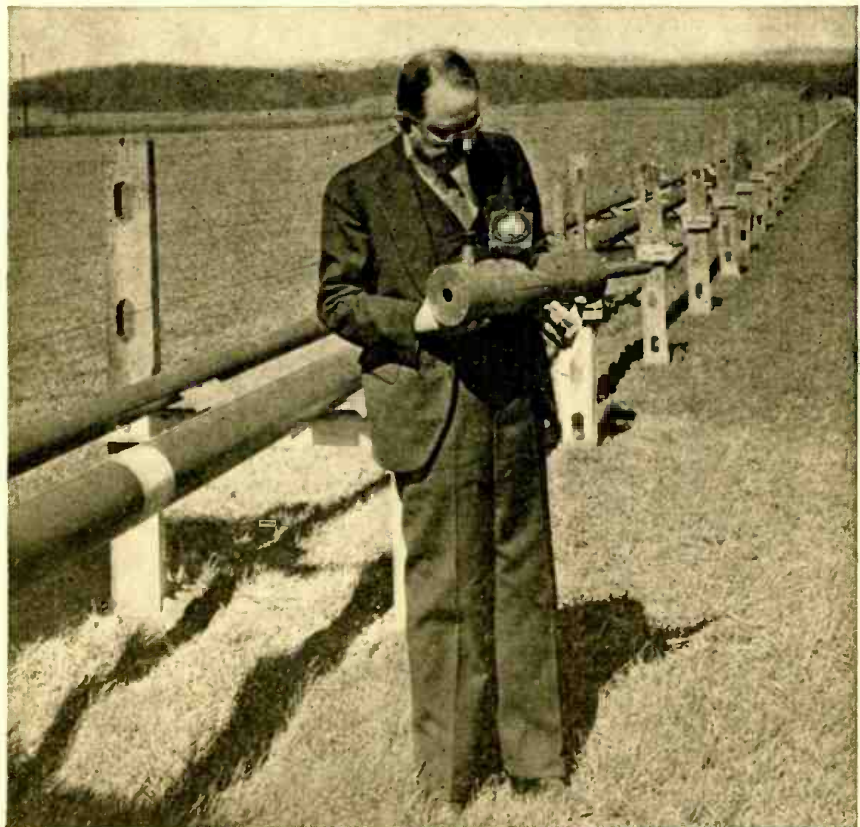
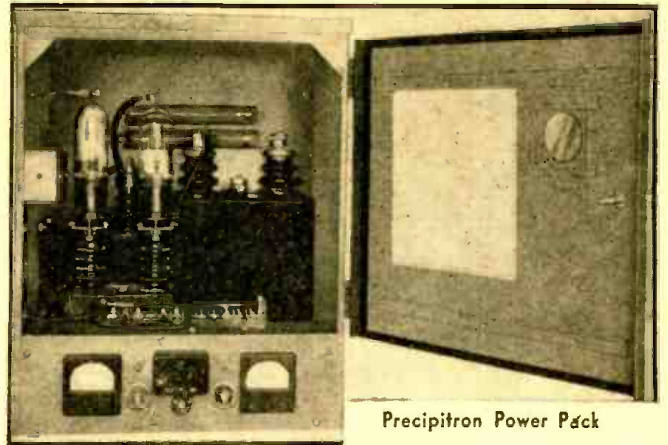

Photo Courtesy Bell Laboratories
Dr. Southworth, with a variable resonator. The small hole mentioned in the text is seen in one end of the resonator. In the background are two waveguides installed at Holmdel.

PRECIPITRON

There are few fields the electron is not capable of invading. From measuring the light of a distant star, or switching the thousands of amperes used in heavy industrial tasks, it now turns to the humble duties of the housemaid, and labors to keep our homes free from dirt. Dust too fine to be removed by other methods poses no problem to the Precipitron.



Precipitron Power Pack

AN electric precipitator of dusts and fumes, that removes particles as small as 1/250,000 of an inch, is a new development of the Westinghouse laboratories.

It started out as a hopeful attempt to keep a hot-air heated home clean. About 1937, Gaylord W. Penney (Manager of the ElectroPhysics Laboratories) was verifying some European experiments with ionized air, and stumbled on an idea which started him off on this new trail.

He first rigged up an electrostatic dirt-trap with some aluminum plates and some wires, with a burning oil-soaked rag as a source of dirty smoke to be removed.

Since his first experiments the device has been developed into a commercial piece of

moved as easily as large pieces of lint or paper dust.

The electric charge, 12,000 volts for the ionizing wire and 5,000 to 6,000 volts for the positive plates, is supplied by a special high-voltage power pack, shown in Fig. 2. The WL-579-B shown here is a special tube developed for the Precipitron, and is rated at 25 milliamperes D.C., with a peak inverse rating of 20,000 volts. Two of these are used in series to supply the high voltage required.

The rectifier output is filtered to some extent by the 10,000-ohm resistor in the 6,000-volt lead, and by a two-section condenser. These are of 0.55 mfd. each, and are shunted by resistors which discharge them within 20 seconds of the time power is shut off, thus reducing danger from shock due to charge remaining in the condensers.

The dusts, fumes, pollens, and tobacco smoke, are attracted to the plates, and stay there. Measurements indicate that about 95% of the air-borne dirt is removed in this way. Curtains in homes which turned dark in a few days, stayed fresh for months. Daily dustings were found unnecessary. And all this cleanliness was achieved at a cost of about \$1.00 per month.

Having proved itself so well in residential application, the device has been adapted to commercial uses, some of which are as follows:

In steel mills and power stations it removes from the ventilating air for electrical machinery, dusts which would otherwise accumulate on the windings, where it would constitute a fire hazard or cause breakdown in insulation resistance.

In textile mills its use has banished soot, smoke, dirt and dust during winding, spinning and drying operations, thus eliminating dirt-streaked thread and yarn.

Telephone exchanges find less trouble with delicate switching relays than was possible with mechanical blow-out procedures formerly employed.

The machine tool industry and precision instrument manufacturers find that there is less haze due to the cooling agents being vaporized by high-speed cutting and grinding operations, and less corrosion with delicate superfinished surfaces.

Hospitals too, benefit by its use since the principal source of danger by atmospheric contamination is reduced by the lowering of the bacteria count in the air stream. The tests have shown this to be so.

Restaurants, night clubs, offices, broadcasting studios—all these have found its use superior to other methods in reducing dust and smoke, and in lowering cleaning bills.

Evidently there is an unlimited future for this marvelous device, the outgrowth of a humble start with a man who wanted to keep his house clean!

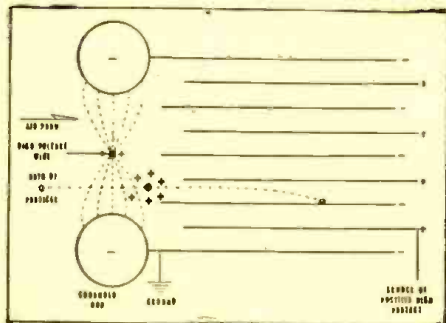

Fig. 1

These units are built up into cells 36 inches high, 31 inches deep, and 8½ inches wide.

apparatus, but just as simple in principle as the first one made.

The air enters one side and passes over fine tungsten wires which carry 12,000 volts. Parallel to the wires are steel plates which are charged negatively.

The two wires are suspended between two grounded tubular electrodes, and the 12,000-volt charge on the wires creates a very strong electrostatic field between the two. Each particle of dirt—regardless of its size—receives a charge passing through this field. Drawn on by the ventilating system, the air passes through rows of parallel plates, which are charged alternately positive and negative. The particles are repelled from the positive and attracted by the negative plates, settling on the latter and remaining there till flushed away in the periodic cleaning of the boxes.

The path of a typical dust particle is shown in Fig. 1.

The principle on which the Precipitron works is as effective in clearing the air of the finest particles as of the larger particles of dust. Thus, the minute particles of tobacco smoke—which may run as small as 1/250,000th inch in cross-section—are re-

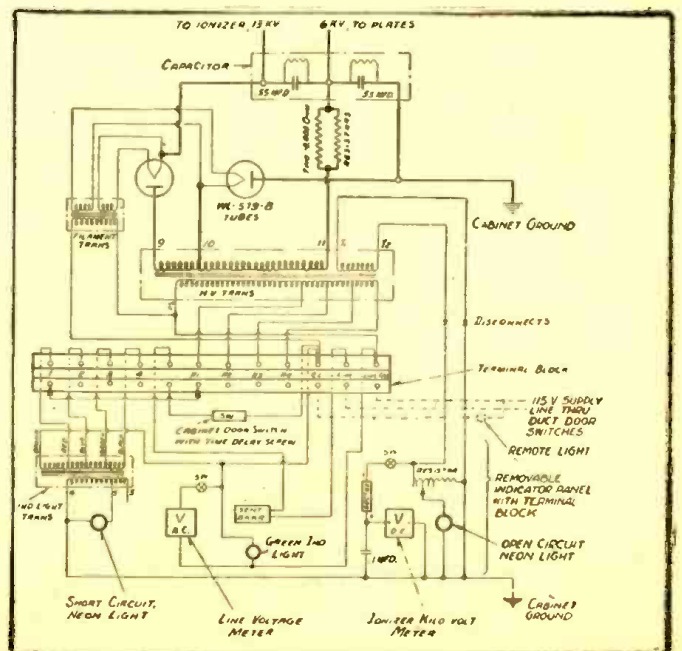

Fig. 2

The Precipitron Power Pack. The tubes are the high-voltage WL-579-B's. The two-section capacitor is shown at the right. Its porcelain insulating bushings are also used as the high-voltage terminals of the instrument.

CHEMISTRY NOW SPEEDED WITH AID OF ELECTRONS

By T. R. RHEA*

THE years 1941 and 1942 were the outstanding years of all time for this industry in the number of new kilowatts of conversion apparatus installed to produce the wartime demand for aluminum, magnesium, chlorine, and copper and zinc. In each of these years, conversion apparatus totalling approximately 1,000,000 kilowatts

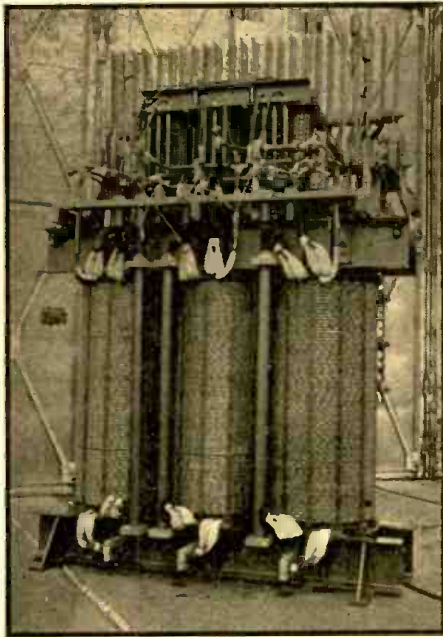

Large furnace transformer for electrothermal production of ferro-silicon and magnesium.

was installed to convert alternating-current to direct-current.

This conversion apparatus included all types and makes, but mercury-arc rectifiers of the ignitron type predominated. In only a few special cases was rotating apparatus installed. Mercury-arc rectifiers are eminently suited to this industry because of their high efficiency and general all-around satisfactory performance.

These two record years, 1941 and 1942, brought the grand total of D.C. kilowatts installed in the electrochemical industry to approximately 3,900,000 kilowatts. Of this grand total, 73 per cent are in mercury-arc rectifiers.

Because of the very high load-factor, the electrochemical processes will be absorbing energy at the rate of approximately 30,000,000 kilowatt-hours per year by early 1943 when all of the new apparatus is in full production. This energy consumption rate ranges from 12 to 15 per cent of all the electrical energy consumed in the United States, and is the largest single item of electrical load.

These figures are for the United States only, and do not include the 1,000,000 or so kilowatts installed in the Canadian electrochemical industry.

HIGH-SPEED ANODE BREAKERS

Nearly all of the mercury-arc rectifiers installed in 1941 and 1942 were equipped

with high-speed anode breakers. These breakers, described in recent technical papers, are installed between the rectifier transformer terminal and the anode of the rectifier. There is one independently operated pole of the breaker for each anode.

When a rectifier arcs back, a short circuit is established on both the A.C. system and the D.C. system. The high-speed anode breaker removes this disturbance from both systems in one-half cycle or less, with no damage to the apparatus and without interrupting the power flow to the process (when several rectifiers supply the process).

The development and widespread use of these high-speed breakers is one of the major developments in the industry. This can be readily understood when we consider the experience of a large chlorine "pot line" installed early in 1942. The effectiveness of the high-speed anode breakers on this installation has been such that since the "pot line" went into operation there hasn't been a single interruption of power flow to the "pot line" caused by arc back.

A particularly interesting application of mercury-arc rectifiers made in 1942 consisted of supplementing each of eight old 10,000 ampere rotary converters with a 3000-ampere mercury arc rectifier. The increase to 13,000 amperes at 580 volts resulted in a considerably increased output of electrolytic zinc. A special automatic current control on the rectifiers permits them to parallel successfully with the rotary converters.

The year 1942 saw an increased use of load-ratio-control autotransformers in the electrochemical industry for obtaining a wide range of D.C. voltage adjustment on the rectifiers supplying "pot lines." These autotransformers permit the application of a wide range of D.C. voltage to the "pot line" by tap changing under load. This is particularly desirable in the operation of magnesium "pot lines" where it may be desirable to start with only one or two cells and add cells gradually. Several such applications permit D.C. voltage adjustment

under load from zero to full voltage, and eliminate entirely the undesirable effects of grid control on the rectifiers themselves.

SEALED IGNITRON RECTIFIERS

About fifteen sealed ignitron rectifiers of the load-center unit-substation type of construction were applied to hydrogen and sodium perchlorate electrolytic cell lines during 1942. The sizes of these ranged from 200 to 500 kilowatts at 250 volts D.C. The



Sealed ignitron rectifier of factory-assembled load-center unit-substation type, installed in a large war plant. 300-kw, 250-v size.

sealed ignitron rectifier is sealed at the factory, and does not require continuous evacuation, as do the larger ratings of rectifiers.

The unit-substation type of construction—where A.C. switchgear, rectifier-transformer, rectifier, and D.C. switchgear are combined as a complete, factory-assembled unit—was borrowed from general industrial power distribution practice.

The general shortage of motor-generator sets and consequent long shipments led to the wide use of unit-substation type sealed ignitron rectifiers for general in-

(Continued on page 572)

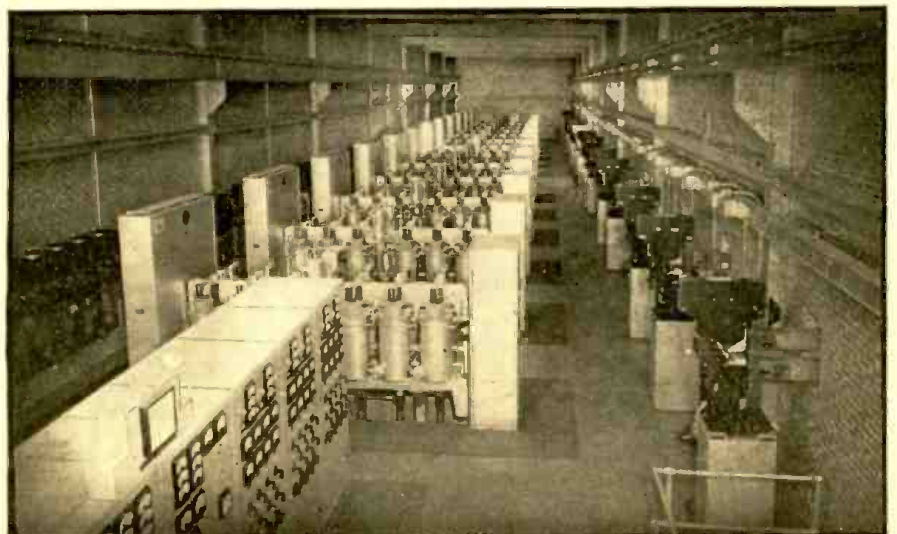

View of 40,000-kw of ignitron mercury arc rectifiers in a large western electrochemical installation.

*Engineer, Petroleum and Chemical Section, General Electric Co.

EMERGENCY RADIO SYSTEM ENLISTS HAM AND LAYMAN

(COVER FEATURE)

WERS IS AN IMPORTANT NEW LINK IN OUR RADIO DEFENSE NET. ITS SPECIAL ORGANIZATION AND EQUIPMENT RENDER IT ABLE TO DO WORK THAT CANNOT READILY BE HANDLED BY ANY OTHER DEFENSE BRANCH. HERE IS AN OPPORTUNITY FOR THE AMATEUR AND CIVILIAN RADIOIST TO AID IN REALLY IMPORTANT DEFENSE WORK!

THE radio amateur, or "Ham"—that experimenter who believes it is more blessed to transmit than to receive—is again active. Put temporarily out of existence by the war order banning all amateur transmission, he is rising again with a new emblem on his wings. This time it is WERS, the *War Emergency Radio Service*, a branch of the Civilian Defense Organization. The duty of this service is to provide communications in periods of emergency, when telephone and telegraph systems may be disabled, or overloaded with other traffic. Alternatively, WERS may be called upon should communications break down because of flood or tornado.

Not that the amateur has remained quiescent since the shut-down order of December 7, 1941. Out of the 55,000 licensed amateurs in the country at that time, more than 16,000 are now actively engaged in the armed services. Thousands more are in essential war jobs where their technical skill has averted more than one labor bottleneck.

But WERS is the field nearest to the amateur's heart. It is like his old game. In many parts of the country, former Hams are devoting all their spare time to organizing WERS, constructing equipment and training new operators. The latter is not too difficult, as most WERS work is done by phone, and the time required to learn

reception and transmission of code is saved.

CONSTRUCTION DIFFICULTIES

War conditions have increased the difficulty of constructing suitable equipment. Apparatus to work at the frequencies used was formerly considered very critical, and was built only of highest grade parts. Now it is necessary to go to the bottom of the Ham junk box, and even to salvage apparatus from ancient broadcast receivers. In spite of these handicaps, and spurred on because of them, WERS constructors have achieved near miracles.

A description of one of these construction jobs, which may be considered a typical WERS installation, is given by an impressed (layman) reporter of the Allentown (Penna.) *Call*, in describing a recent blackout. The set described was operated by Karl Wiegandt, one of 15 WERS operators working in a group in that district:

"The radio he operates is a two-way set and weighs a little over two and a half pounds, and can be operated wherever the operator may be. He can place it on his back and walk through the city receiving orders from the center and sending answers. The radio has a voltage of 105 volts."

ADVANTAGES OF WERS

This walkie-talkie feature is one of the strongest points of WERS. It is practically

invulnerable. One bomb may put the biggest telephone exchange out of action. It is impossible to imagine an attack which would put WERS out of action. The little self-powered units can move wherever a man can. Even though one or more of the central stations should be silenced, traffic could be routed through another with a minimum of delay.

Second only to the invulnerability of WERS is its mobility. Most of the smaller sets are constructed so that they can be carried by one man, and even used while in motion. Thus they can be operated at the scene of any emergency without loss of time, and can even be used from moving vehicles. Even the larger stations and centers are constructed with an eye to the possible necessity of moving them, and all installations are independent of local electricity for their power.

Springing from the portability and independence from all external power supply, as well as from the traditional amateur system of operation, is the third advantage of the WERS set-up—its flexibility. Many points can be reached simultaneously from one central point. Thus the slower telephone chain calling is eliminated. Listening operators can break in to give advice or information—in the fashion of the old amateur "round table"—or, knowing the exact



Courtesy New York Telephone Co.

Feminine Civilian Defense radio operator transmitting from one of the mobile stations of the New York City WERS.



Official OCD photo from OWI

Two Civilian Defense radio operators stand by the controls of WERS equipment in the West Control Center in Akron, Ohio.

situation by listening to calls to all points, can guide their own groups better.

The FCC has assigned a number of frequencies for WERS work. The most important of these are three bands used as follows:

Band 1.—Connects the local Civilian Defense control center with the district control center and so reinforces the community's outside communications.

Band 2.—Connects the local control center with local fixed points such as warden's posts, fire houses, public utilities, and industrial plants.

Band 3.—Connects mobile units, such as fire trucks, medical teams and the walkie-talkie units with the control center.

Other bands assigned can be swung into use for any particular local or temporary need, there being practically no limit to the flexibility of the system.

EXPANDING RAPIDLY

The WERS plan was announced some time ago, but in its early stages was hampered to some extent by misunderstanding as to the functions of the service, methods of organization, and the separate responsibility of municipal organizations, the OCD and the volunteer groups interested. Now that these early difficulties have been straightened out, WERS is expanding rapidly. To date there have been more than 215 applications for licenses (each license is granted to a municipality), about 4500 operators permits have been issued, and there are more than 3,000 actual units in operation.

New York City claims the "largest emergency radiotelephone service of any community in the world," its WERS corps numbering over 300 operators and 133 functioning units scattered through the five boroughs. Regular drills are conducted weekly, and the service participates in all blackouts and air-raid tests. The local WERS run classes to train applicants for the restricted radiophone operators' permits required, and maintains a shop where apparatus loaned or given to the city is revamped into equipment suited to the work in hand.

The operator of the walkie-talkie in the cover picture* is using a receiver-transmitter built up by the construction section of the local WERS. As shown in another picture, these sets are admirably adapted to automobile operation.

Fixed stations—many of them designed to be moved quickly should they be needed in other spots—while less interesting to the casual observer are even more important links in the network co-ordinating a district control center with all the corners of its assigned area.

Other points have developed WERS organizations as efficient—if not as extensive—as that of New York. Most of these are along the coast, as the delusion that inland points have less need for such services has hampered work in many inland areas. This is being overcome and several excellent reports have been received from Middle West districts.

The greatest difficulty to be overcome is that of the shortage of skilled technical help in constructing and operating the necessary apparatus, and in training the new volunteers, whose willingness usually far outruns their knowledge of this type of work. As these gain in skill and technical ability, many of them will be available for the training of further newcomers.

The 5,000 Hams available for the work are faced with a tremendous program. They intend to put into operation 100,000 transmitters—mostly of the small mobile type—a minimum of 200,000 receivers, and to train a corps of operators for them. The assistance of all radio experimenters and enthusiasts who have the requisite skill to help in construction or the willingness to undergo the training courses for operators will be necessary to put this program over.

Radio-minded individuals who get in touch with their local offices of civilian defense will find this an effective way to help in the prosecution of the war on the home front.

*Photo courtesy of the New York Telephone Co.



Official OCD photo from OWI

Two volunteers assembling WERS equipment from old broadcast sets and other radio scrap obtained in a community drive.

NO MORE NEW PARTS

AN action long anticipated by experimenters and constructors has now taken place. The War Production Board, in its Limitation Order L-265, has stopped entirely the sale of all types of electronic equipment not intended for use in important war work, or for the maintenance of existing civilian equipment. The Order says, in part:

"No producer or supplier (other than Defense Supplies Corporation) shall transfer any electronic equipment to any consumer, nor shall any consumer accept the transfer of any electronic equipment from any producer or supplier (other than Defense Supplies Corporation) except:

To fill preferred orders (Army-Navy, etc.—Editor), or

To fill orders bearing a preference rating of A-1-a or higher, or

To fill an order for any component part of electronic equipment provided the consumer delivers to the producer or supplier concurrently with the transfer a used, defective or exhausted part of similar kind and size which cannot be repaired or reconditioned; or when circumstances render the delivery of a part for a part impractical, provided the consumer's purchase order (or written confirmation thereof) is accompanied by a certificate in substantially the following form:

I hereby certify that the part(s) specified on this order are essential for presently needed repair or electronic equipment which I own or operate."

This is the text of the "part for part, and tube for tube" order so much publicized recently.

"Electronic equipment," by-the-way, is defined in the order as, "Any electrical apparatus or device involving the use of vacuum or gaseous tubes, and any associated device, apparatus, or component part thereof."

"Acoustic phonographs" are especially included, but hearing aid devices are excepted, as are wire telephone and telegraph equipment, electric batteries, power and light equipment, and medical, therapeutic and X-ray equipment other than replacement electron tubes therefor.

This definition is wide enough to cover all items used in radios, sound devices and projection equipment.

The order is altogether proper and necessary. It is absurd, of course, that radio parts should be available to the home constructor or even the serious experimenter, when such parts are needed in combat apparatus. The priority system was expected to solve this problem, but it is a matter of experience—at least to shoppers in large centers—that a great deal of stuff was available as "junked" or "surplus" stocks which (apparently) was perfect replacement material, and which will now have to be used as such.

The radio enthusiast is not, however, compelled to sit and twiddle his thumbs. Some months ago, *Radio-Craft* pointed out that we must shortly expect all new material to be cut off, and that construction of "junk-box" apparatus must increasingly occupy the attention of the experimenter. Since that time we have printed circuits of receivers, amplifiers and even test apparatus, all made without the use of any new material.

As junk-boxes run low, the experimenter will find a never-ceasing source of supply in the old broadcast receivers which are to be found in so many attics, closets and basements all over the country. Old B-eliminators will supply transformers and chokes. As many as eight pairs of headphones have been found hanging on one hook, relics of the pre-loudspeaker era, but all eight in good condition.

This is also the answer to the problem of the new student of radio, "Where am I to get stuff to experiment with?" His problem is even simpler than that of the old-timer, since he is interested chiefly in increasing his knowledge.

Possibly life has been a little too easy for the radioist in the past few years. The facility with which completely-assembled equipment could be purchased tended to discourage individual construction, without which no one ever learns a great deal about radio. We look for a more advanced class of radio experimenters—both theoretically and practically—as a direct result of the present situation.

NEVER TAKE IT FOR GRANTED!

By MARION CROWELL

RADIO is one business in which we cannot—indeed we *must* not take *anything* for granted. Sometimes the simplest of troubles “stumps the experts” the longest. You may make static tests on individual parts, tubes, etc., until you are black in the face only to have them go bad after they have been replaced in the receiver under actual working conditions.

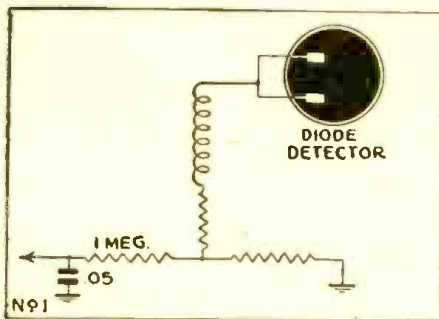

This article is being written in the hope that it will help those just beginning a career of radio servicing as well as showing some of the “old timers” a trick or two they possibly had overlooked.

First, never take it for granted that you can do a good job of repairing radios without proper equipment. While it is true that you can fix *some* of the radios *some* of the time with a “voltmeter and a few little things”—to fix *all* the radios that come in *all* the time and in a hurry—you *must* have adequate equipment. Troubles dealt with in this article are not the most common type. Instead the author hopes to help some few with the type troubles that are inclined to make a serviceman’s hair gray prematurely.

Take, for instance, the coupling condenser. Just a small hunk of wax, paper, and foil; but boy, how that little rascal can disrupt the proper operation of an otherwise very nice radio! The intermittently open type gives the trouble of sometimes transferring the signal from one source to another, and at other times refusing completely to let a signal through at all. That type can usually

be found by twisting or tapping lightly the condenser, thus making it cut in and out.

That is only one type of the troubles caused by this little item! Sometimes we get a set in for repair on which all reproduction is terribly distorted. One of the most common causes of distortion is improper bias on the grid of the power output tube. Perhaps the power output tube should have a negative potential of 15 volts. Checking this with an electronic voltmeter (there’s an instrument you *must* have even if you build it yourself!) you find you have only 5 volts on the grid of that tube. Clip loose the coupling condenser. If you now get proper bias on the tube, clip out the coupling condenser completely and replace with a new one. Don’t go to the trouble of testing the condenser with your analyzer or ohmmeter. It probably would test “good” from now on, but it had a high resistance leak that was shown up by what it actually did under actual operating conditions.

BIAS RESISTOR TROUBLES

Don’t always take it for granted that the coupling condenser is bad when a receiver is intermittent and has improper bias on the power output stage. If you suspect the coupling condenser it won’t hurt to replace it. But sometimes the blame lies elsewhere. Sometimes bias resistors change in value, sometimes you will find cathode by-pass condensers shorted, and sometimes gassy or otherwise defective tubes cancel out a large portion of their bias. The shorted by-pass condenser can be easily detected by routine check, but you will find, occasionally, tubes that check O.K. in tube testers that, through some defect, cancel out a great portion of their bias after a few minutes of actual operation in a receiver.

While we’re on the subject of tube bias, here’s the author’s suggestion for testing same: hook one test prod of the voltmeter (must be an electronic type) on the cathode of the tube to be tested. Put the other on the actual grid of that tube. Now, if all components in the grid circuit are O.K. we will get the reading prescribed by the tube manual. This gives a quick check on everything in the grid circuit of that tube (transformer winding, grid resistor, cathode resistors and its associated by-pass condenser as well as connections of such components to chassis, etc.). Time was when we checked the voltage across the cathode resistor and took it for granted that the grid was negative with respect to the cathode by that many volts. Such a system gives too many chances for an erroneous reading. The system recommended above will give you the *actual* bias on the tube.

A.V.C. CONDENSERS

Now take another little by-pass condenser used in the A.V.C. bus. (See diagram No. 1.) It has neither end hooked to a high voltage source—in fact one end is grounded and the other end is hooked into low voltage A.V.C. bus through which no actual current flows. How easy it is to assume that this little fellow is O.K. But let’s look in on Mr. Jones as he listens in for

war news on his Model 11G Grunow. (This is an actual trouble encountered quite regularly in this particular receiver.)

Mr. Jones has just lighted up the old pipe and settled back in his favorite chair. He has just finished hearing one hour of soap, dental cream and Vitamin pills.

“Ladies and gentlemen we have good news for you,” finally begins the news commentator. “A group of some 1500 heavy bombers has just returned from Berlin where”—and there suddenly and with a maddening calmness the velvet smooth announcer’s voice is transformed into a unique sort of squeal! Mr. Jones cusses, cries, tears his hair; finally, in desperation, flips the short wave band switch a couple of times. The radio clears up, starts talking again.

“Also bombers have finally started their work on Tokyo. Last night—squeee-ec-eee-ee!” And there it again breaks into oscil-

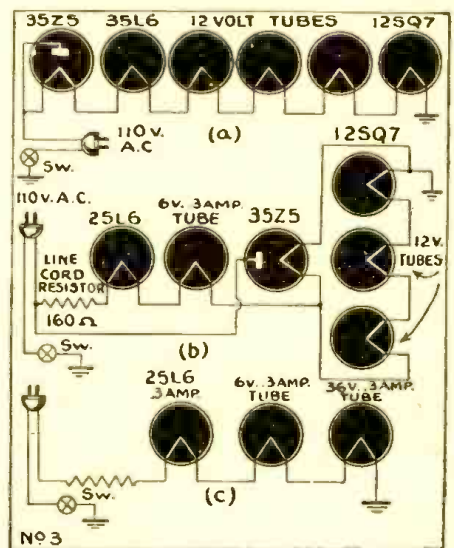

lation! And maybe next day the radio performs perfectly all day long! That is the kind of trouble you will find caused by a defect in that particular by-pass condenser. The most reliable check for such a condenser is to “get rough” with it under actual working conditions. Twist it, tap it with a pencil and abuse it generally. If you’re lucky maybe your trouble will show up, cutting in and out as you twist or tap this condenser. Your best rule with respect to this condenser is: “When in doubt, cut it out!” A new condenser costs you only a dime or so—and your time is too valuable to waste.

HIGH-RESISTANCE TUBE LEAKAGE

We all know that tube testers are not too reliable as to poor tubes. Sometimes a receiver, after thirty minutes or so of operation, will suddenly pop on louder and then, at various intervals, suddenly decrease in volume.

“Aha,” you say. “Merely a bad coupling condenser.” But is it? You hook the old electronic voltmeter into the A.V.C. bus,

(Continued on page 562)

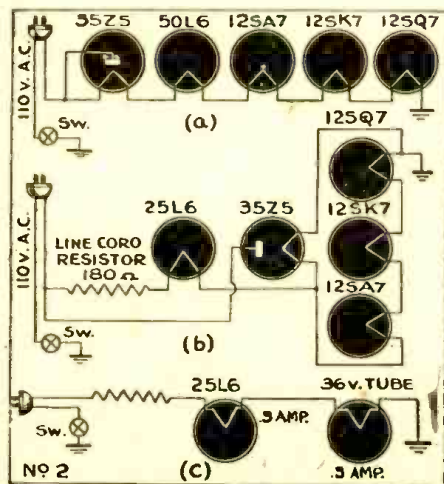

HOW METERS ARE REPAIRED

By F. J. LINGEL*

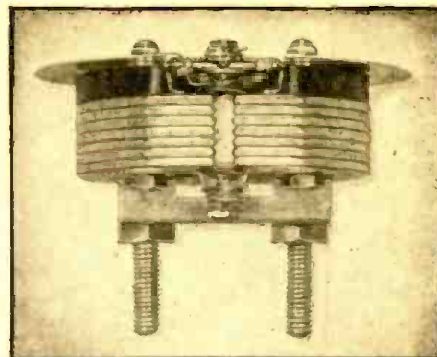

View of meter from bottom, showing front and rear mountings of moving coil.

REPAIR of burned-out meters is no job for the amateur. Only if he has had considerable experience in making minor meter repairs, *knows that his skill is sufficient*, and has an excellently equipped shop, should he attempt this kind of work.

Besides the special equipment mentioned in the last article, a standard meter with which the repaired one can be compared is also necessary. A means of demagnetizing the meter magnets is also required, as well as a "magnet charger" or magnetizer. For the man who has only a few meters to work with, the ordinary type of magnetizer used by garages will work well enough. Meter manufacturers use a special set-up, which may be described later.

If replacement springs and moving coils are available, the serviceman may proceed to operate as follows: First the movement is thoroughly demagnetized by holding it in the alternating-current field of a demagnetizing coil. This can be wound with several hundreds turns of wire in a 3-inch loop, or may be borrowed from the local jeweler. If a home-made loop is used, work it in series with a large electric heater or other resistor which will permit several amperes to flow but will not burn out the shop fuses. The wire can be permitted to get hot, as it is used for very short periods.

De-magnetizing is accomplished by holding the movement in the strongest part of the A.C. field and slowly withdrawing it. Test with a small nail to see that all magnetism is removed.

REPLACING SPRINGS OR PIVOTS

Now remove the mechanism assembly from the case and dismount the scale plate or dial. Unsolder the top and bottom springs, taking care to protect the spring and pivots from any spattering of flux or solder. Loosen both the top and bottom jewel nut and screw assemblies and carefully remove the armature or moving coil.

*Triplett Electrical Instrument Co.

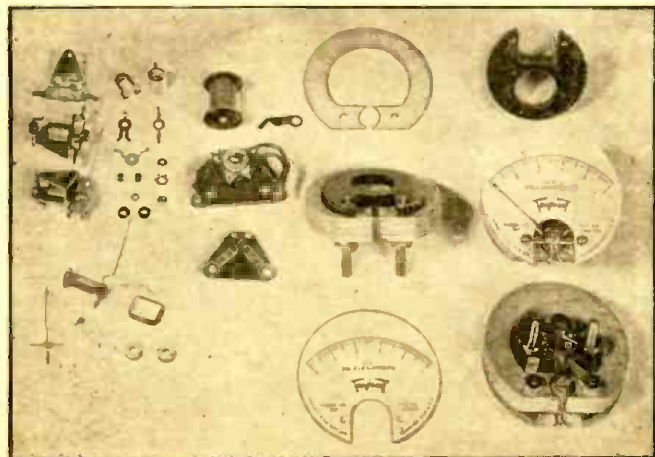

The parts that go into a typical meter. At extreme left are shown the moving-coil components in various stages of explosion and assembly. A resistor shunt and thermocouple unit are shown next to the right. The other items are all self-explanatory.

Pivots or springs may now be replaced, using great care to obtain good electrical and mechanical connections during any soldering operations and keeping the parts free from any spattered flux or fumes from the soldering.

Parts may be protected from splatter by covering them with pieces of thin lintless paper, such as lens paper. When soldering the spring to the moving coil be especially careful to protect the pivot. Place a small

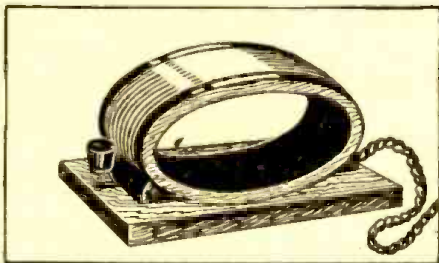

A simple type of watch demagnetizer.

tubular cover over it, as the smallest bit of foreign matter on it may cause rust. Solder the outer convolution of the spring to the abutment on the bridge by holding the iron to the abutment and allowing the solder and flux to flow over the spring. Again: Use as little solder and flux as possible!

MAKING ADJUSTMENTS

The assembly may be done in reverse order, setting the pivots and jewel clearance at approximately 0.003 inch total—that is, 1½ thousandths of an inch on each side. Clean the armature core and frame assembly *carefully* of any filings or dirt before it is remounted in the magnet. A small (1-inch) paint brush will be found useful for this work.

The design of the Triplett mechanisms—that is, the moving coil, core and frame—is such as to allow for inspection and align-

ment of that part of the assembly before it is placed in the magnet. Do not attempt to make final adjustments of the pivot to jewel clearance until the moving system is securely fastened to the magnet, as small amounts of stress will be applied to various portions of the frame which in turn will tighten up on the pivots if they are adjusted too close.

In dealing with other models, it will be necessary to inspect the particular manner in which the various portions of the assembly are mounted, and be guided accordingly.

The magnet is now recharged to a strength which will result in a sensitivity of at least 10% over the previous sensitivity. Exact adjustments may now be made by holding the completed unit in the demagnetizing coil. Take care not to apply too much current to the demagnetizer, and reduce the magnet strength till the meter reads correctly as compared with a known "Good" instrument.

MAGNET CHARGING

The usual garage type of magnetizer will often be found inconvenient for magnetizing work when the ends of the magnet have a meter movement mounted in them. Manufacturers use a heavy copper bar placed through the magnet to be charged, and pass extremely strong currents through them. The currents are so large that special switches, etc., must be used.

Where the amount of work will justify it, the recharger may be constructed with the help of a few bars of copper. Six to ten 6 or 8 volt storage batteries should be connected in parallel, through heavy cable leads, to 1-inch copper bar. A switch may be made out of two copper blocks 6 x 1½ by 36 inches. It should be immersed in an oil bath, to break any arc. In operation a butt connection is made between the two bars along the 1½ inch side. Rigidity is the reason for making the bars 6 inches deep from the switch face. (The above describes apparatus in use, and will give the reader an idea of what is required. Individual variations may be made to suit apparatus at hand.)

The bar on which the magnets are placed is also a 1 inch copper bar. The batteries should be of the heavy-duty automobile type, and of as large ampere-capacity as can conveniently be obtained.

INSTRUMENT SPRINGS

Any given model of instrument may have one of several different springs, depending not only on the range but the particular sensitivity, scale characteristics, type of pointer, etc. It is therefore impractical to attempt to identify each spring by the model number of the instrument. The following procedure for spring replacements is suggested:

Carry a stock of approximately six of
(Continued on page 563)

EMERSON RADIO
Models FH-413 and FH-440

DESCRIPTION

TYPE: Two-band superheterodyne.
 FREQUENCY RANGES:
 540-1620 kc. (555-185 meters)
 8.8-12.2 (16.3-24.5 meters)
 NUMBER OF TUBES: Six.
 TYPE OF TUBES:
 1—6SG7 or 6SD7 or *7H7
 1—6J5, oscillator
 1—6SK7 or *7A7, I.F. amplifier
 1—6SQ7 or *7B6, diode detector, a-f amplifier, a.v.c.
 1—25L6, beam power output
 1—25Z6, half-wave rectifier
 POWER SUPPLY: A.C. or D.C.
 VOLTAGE RATING: 105-125 volts.
 POWER CONSUMPTION: 30 watts.
 *Some receivers use lock-in tubes instead of equivalent octal types. Due to different socket requirements these tubes are not directly interchangeable.

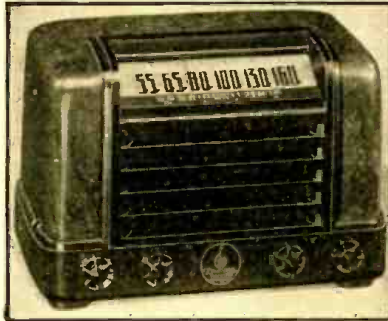

The Emerson FH-413 two-banded table model radio receiver.

GENERAL NOTES

1. If replacements are made or the wiring disturbed in the R.F. section of the circuit, the receiver should be carefully realigned.
2. In operating the receiver on D.C. it may be necessary to reverse the line plug for correct polarity.
3. The color coding of the I.F. transformer leads is as follows:
 Grid—green Plate—blue
 Grid return—black B plus—red
4. The self-contained loop antenna has directional properties. It is important, therefore, once the station is tuned in, that the cabinet be rotated on its base back and forth through a quarter of a circle (90 degrees), and left at the position where the station is received with maximum volume.

VOLTAGE ANALYSIS

TUBE	PLATE	SCREEN	CATHODE	F.I.L.
6SG7, 6SD7 or 7H7	92	63	0	6.3
6J5	102	—	0	6.3
6SK7 or 7A7	102	102	0	6.3
6SQ7 or 7B6	30	—	—	6.3
25L6	92	102	6.5	25

Voltage at 25Z6 cathode—150 volts.

Voltage across speaker field—32 volts.

Readings should be taken with a 1000 ohm-per-volt meter. Voltages listed below are from point indicated to B minus (line switch) with the volume control turned on full and no signal. Line voltage for these readings was 117.5 volts, 60 cycles, A.C. All readings except heaters and cathodes were taken on 250 volt scale. Measurements made with 117.5 volts D.C. will be lower than those given on the left.

Voltage across pilot light—4.5 volts.

ADJUSTMENTS

R.F. ALIGNMENT

Rotate the wave-band switch counter clockwise to the short-wave position. Set the dial pointer at 12 megacycles and using a 400 ohm carbon resistor as a dummy antenna feed 12 megacycles from the generator to the external antenna lead emerging from the rear of the chassis. Adjust first the short-wave oscillator trimmer and then the short-wave antenna trimmer for maximum response.

Rotate the wave band switch clockwise to the broadcast position. Set the dial pointer at 160 and feed 1600 kc. from the signal generator into a loop of wire about 12 inches

in diameter. Hold this radiating loop about 12 inches from the loop antenna and advance the signal generator until a deflection is obtained on the output meter. Adjust first the oscillator trimmer (rear section of the variable condenser) and then the antenna trimmer (front section of the variable condenser) for maximum response.

If the loop has been replaced it may be necessary to adjust the loop inductance as follows: Align at 1600. Set the pointer at 60 and feed 600 kc. into the radiating loop. A portion of the outside turn of the loop may then be swung to either side of the center to give maximum response. Realign at 1600.

PARTS LIST

SYMBOL	DESCRIPTION	SYMBOL	DESCRIPTION
L1	Loop antenna assembly	C7, C8, C9	Trimmers, part of I.F. transformers
T1	Double-tuned 455 kc. first I.F. transformer	C10	Trimmer and 0.0001 mf., mica condenser, part of T2
T2	Double-tuned 455 kc. second I.F. transformer	C11, C20	0.002 mf., 600 volt tubular condenser
T3	Short-wave antenna coil	C12	0.02 mf., 200 volt tubular condenser
T4	Two-band oscillator coil	C13	0.05 mf., 200 volt tubular condenser
R1, R11	60,000 ohm 1/4 watt carbon resistor	C15, C17	0.02 mf., 400 volt tubular condenser
R2	5,000 ohm 1/4 watt carbon resistor	C16, C18, C21	0.00022 mf., mica condenser
R3, R4	3 megohm 1/4 watt carbon resistor	C28	0.05 mf., 400 volt tubular condenser
R5	60,000 ohm 1/4 watt carbon resistor, part of T2.	C19, C25	0.00011 mf., mica condenser
R6	Volume control: .5 megohm	C22	0.00046 mf., mica condenser
R7	10 megohm 1/4 watt carbon resistor	C23	0.1 mf., 200 volt tubular condenser
R8	600,000 ohm 1/4 watt carbon resistor	C24	0.01 mf., 400 volt tubular condenser
R9	Tone control: 400,000 ohm	C26, C27	Dual 20 mf., 150 volt dry electrolytic condenser
R10	140 ohm 1/2 watt wire-wound resistor		
R12	Ballast resistor, 155 ohm		
C1, C2	Two-gang variable condenser		
C3, C4	Trimmers, part of variable condenser		
C5	Trimmer, part of T3		
C6	Trimmer, part of T4		

PRODUCTION CHANGES

1. Chassis bearing serial numbers above 4,671,200 use a slightly different loop antenna and second I.F. transformer. Note serial number when ordering replacements.

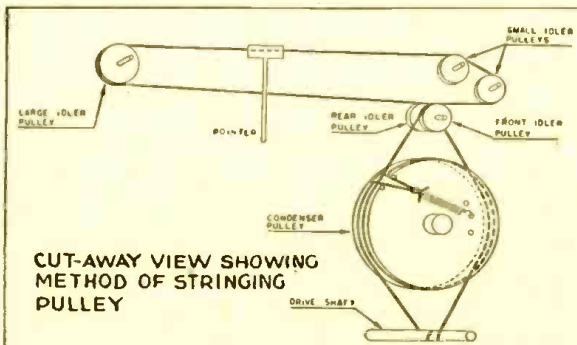

CUT-AWAY VIEW SHOWING METHOD OF STRINGING PULLEY

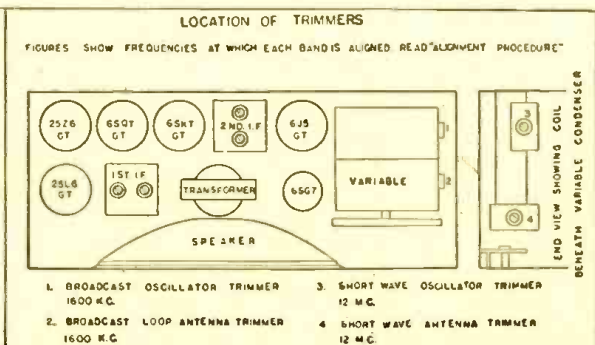

1. BROADCAST OSCILLATOR TRIMMER 1600 K.C.
2. BROADCAST LOOP ANTENNA TRIMMER 1600 K.C.
3. SHORT WAVE OSCILLATOR TRIMMER 12 M.C.
4. SHORT WAVE ANTENNA TRIMMER 12 M.C.

Radio Service Data Sheet

334

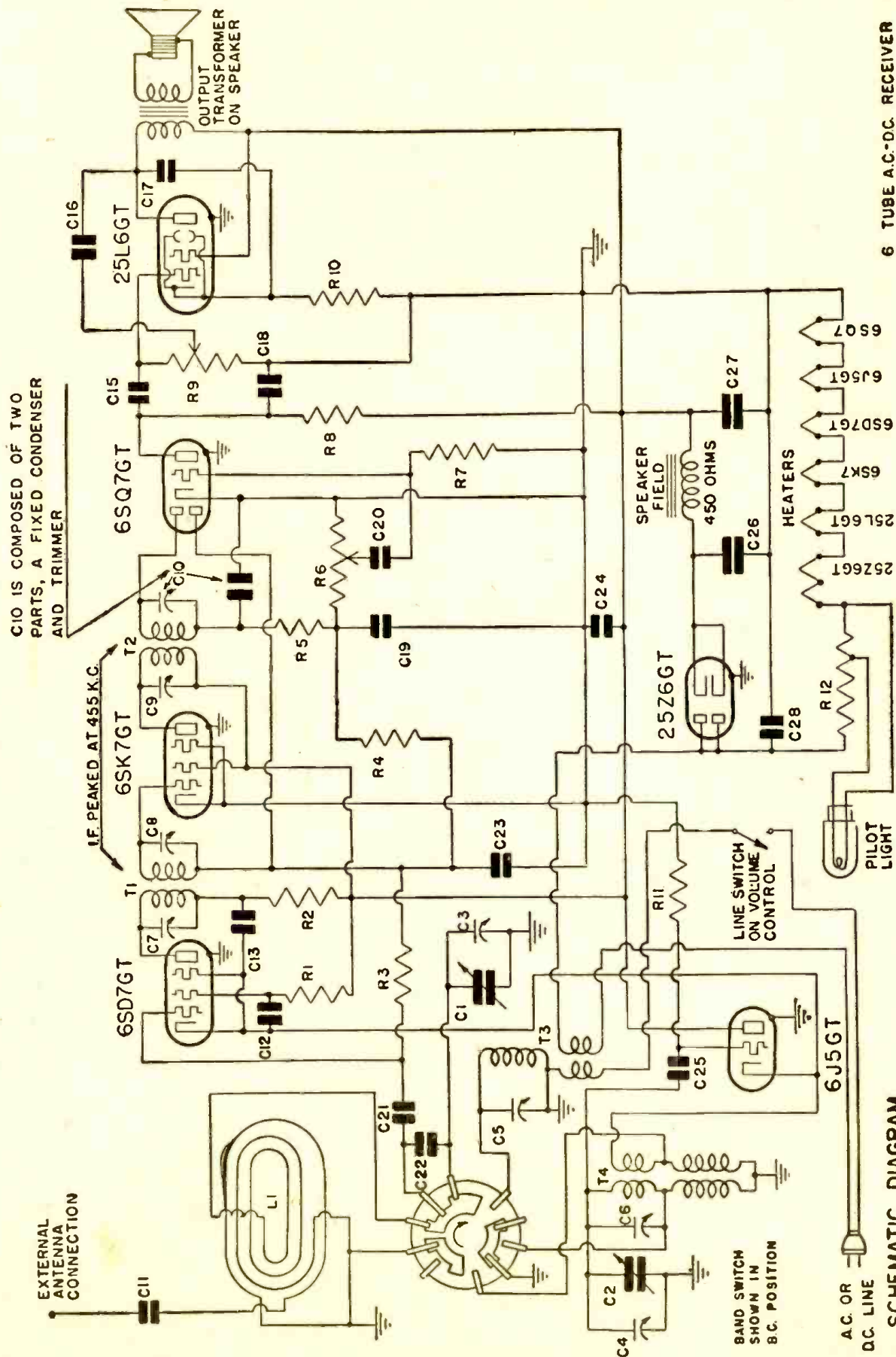

HOME RADIO REPAIRING IS COSTLY NONSENSE

By FRED SHUNAMAN

Radio Repairmen report that an old and unfortunate fallacy is again gaining wide currency. All Servicemen owe it to themselves and their trade to campaign ceaselessly and intelligently against this mistaken idea.

FROM letters received, it appears that radio repairmen are having a new form of an old trouble. Many radio owners want the repair jobs done in their own houses. When the serviceman protests that he can neither test nor repair the set properly in his customer's home, Mr. Set-Owner has a ready reply. He waves a sheet of "advice to radio users" from a Washington bureau. Here, sandwiched in between some excellent hints on keeping the radio in good condition, is an item urging set owners to insist that all repairs be done on the premises. "Modern radio service companies," he reads, "have apparatus with which radio receivers can be tested in the home!"

Modern radio companies do, indeed, have excellent portable equipment, but it is just such companies who have also the latest bench apparatus, with which radio servicing can be speeded up and the cost to the customer cut down. Nobody ever heard of an outside man being sent around to a customer's house with a channel analyzer, a cathode-ray oscilloscope, a signal generator, tube checker and the usual multimeter! Neither is it likely that there is any housewife who would countenance the setting up of a young radio laboratory in her parlor.

The little back-door serviceman is the only one to benefit from this arrangement. He can work almost as well in his customer's parlor as in his "shop." Smoking a cigarette to cover the odor of burning carpet, he cheerfully disembowels the set on the living-room floor. Finding (often) the defective part, he goes to his shop and brings back a substitute. Time is worth little to him. If the set is out of alignment or has other troubles than the one he has discovered, he is not interested.

He makes his repair, collects his bill, and departs. After two or three such "repairs" the owner finds it necessary to send the set

to a large service shop for a thorough overhaul.

It would be impossible for any reputable service organization to follow such methods. The best trouble shooters and the valuable equipment must be kept at the bench, where they can be used continuously, instead of spending time riding around town on service calls. Both in men and equipment, outside work must necessarily take second place.

Once trouble is discovered, any one of a few thousand parts (to cover only the standard brands of home receivers) may be needed. The home serviceman must make a second trip to get the needed piece (unless he has a truck of spare parts outside the door). This costs money. In the long run—money for radio repairs must be paid by the radio user.

There might be some justification for wishing to have a repair on a motor car done in one's own yard. Many types of damage to a car could be made much worse by a trip to the garage. The garageman is not impressed by such reasoning. He goes to the trouble of sending a tow car around and dragging the busted machine to where it can be repaired properly.

There is no justification for home repair of radio receivers. Even the largest can be readily removed from the cabinet and taken to where it can be repaired cheaply and efficiently. Tests can be made and operations performed which could never be done in the owner's parlor. The set can be sent back guaranteed in good condition. All these advantages are lost to the householder who desires home repair.

The advantage, indeed, is all to the "gyp" or the green kid who has been distributing his cards advertising "home radio repairs." Not having any equipment other than the usual multimeter, it is immaterial to him

where he works. No more time is lost going from the customer's home to the parts jobber than would be lost going from his own attic "laboratory."

The "gyp" is especially encouraged. Not having any investment to worry about, he charges what the customer looks good for. Firms who have a large amount of funds sunk in leases, fixtures, and shop and test equipment have to consider the advertising value of their customer contacts. Not so the "home service expert" who knows he will never have a second chance at the same set.

No matter from what angle it is taken, all the arguments are in favor of shop and against home servicing. Why, then, does the customer so often request it? The answer is that previous experiences with radiomen have left him so distrustful of the whole fraternity that he is actually afraid to let his set out of his sight. Every honest serviceman will admit this fact.

The honest serviceman will not permit himself to accede to a customer's unreasonable demands because of such fears. If he does, one of two things will happen. He will repair the set properly at an excessive cost; or because of lack of thorough testing, he will partly repair the set and leave incipient troubles which may cause it to break down shortly. In the former case, the customer will pay the bill and be convinced that the serviceman is a robber, or the serviceman will pocket the loss due to inefficient servicing methods. In either case repetitions of this will put him out of business. That way lies bankruptcy!

If the set breaks down in a week or two he will again get a black eye, and be invited back to do a free repair, or be passed over by the set owner as incompetent, inefficient and crooked. Another repairman is sent for, and the home serviceman is blackballed by Mr. Set-Owner from that time on. If the second man has guts enough to insist on taking the radio to where he can do a good job on it, he will likely gain the owner's trade for life.

It is a pity that this well-meant, but damaging advice has gained so wide currency. The serviceman can do two things about it. First, he can jealously maintain his reputation for honest and competent work, even if it means the loss of a few home jobs. *A Radio serviceman's only asset is his reputation!* That is true of the serviceman as it is of no other professional class.

Second, backed up by a solid reputation for integrity and efficiency, he can run a campaign of education among his customers. A photograph of his bench and the assurance that every one of the instruments on it is useful will often do the trick. It is not an easy job, but most customers can be made to understand that, "It is easier to take a set to the shop than to bring the shop to the set."

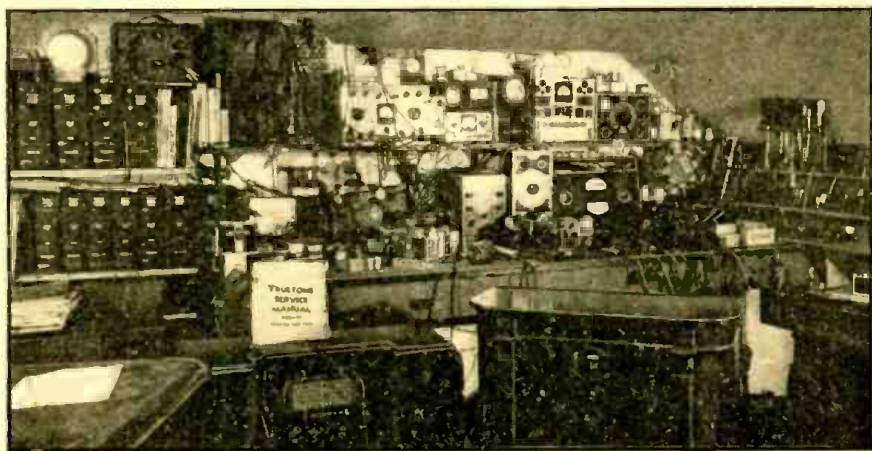

Equipment on this bench and bookshelf represents several hundred dollars. If any single one of these instruments were not needed, the shop-owner would not have spent his hard-earned money for it. This is the best argument against home servicing.

THE SERVICING OF 3-WAY PORTABLES

By JOHN KEARNEY

THE A.C.-D.C. set, the straight A.C. receiver and the straight battery portables have received their share of attention. However, there is still the three-way portable, and that particular form of radio, which enjoyed such wide vogue before the advent of battery shortages, is still widely used today—but on A.C. or D.C. power lines.

Fundamentally, of course, there is no great difference between this kind of radio and an ordinary A.C.-D.C. set, with the exception of the filament circuit which is D.C., operated so far as the receiver proper is concerned. That is, when the radio is connected to an A.C. line the rectifier tube will have A.C. going through the filament but the other tubes will not. They will be carrying D.C.—if the rectifier power system is operating correctly. But we often find that it isn't, and hum is heard or the set is dead altogether.

The replacement of a filter condenser is a relatively simple job, and they are checked readily. Failing to cure the trouble in this way the usual expedient is to check by substitution the condenser connected to the filament of the output tube. This condenser, if it opens up, will allow A.C. to go through the D.C. type filaments and shorten their life. In some cases repeated tube failures are due to a breakdown in this condenser, so that it is a good idea to disconnect the unit and check it for leakage if you have a condenser bridge. The ohmmeter indication is not always a reliable check. However, an experienced man may be able to judge pretty well the relative condition of the condenser by using the ohmmeter.

Another common trouble is an open shunt resistance across a filament. Resistances, therefore, should be checked before the power to the receiver is turned on. This will cut down on tube mortality, prevent unnecessary destruction of tube filaments due to excess voltage being applied.

ALIGNING TROUBLE

In aligning receivers of this kind, you sometimes find that on A.C. operation a rotten tunable hum is heard. In many cases this is due to a defective condenser connect-

ed to the rectifier plates, but may also be due to the use of the signal generator. If the generator is connected to the grid of a 1N5 I.F. amplifier for example and the generator itself happens to be powered by a half-wave rectifier system, considerable hum may be introduced. In testing by the stage-by-stage method, distortion may be introduced which will make it difficult to find the fault or cause of distortion in the receiver itself.

To get around this difficulty a 1 to 1 line transformer can be used. However, such transformers are costly and may not, under present war conditions, be obtainable at all. As a practical alternative it is found that if a small transformer is used for the R.F. there will be no distortion introduced. There is a certain amount of leakage but usually this can be neglected and the scheme works well, permitting normal use of the attenuator on the generator. When the time comes to align the R.F. circuit—the loop antenna, a small pickup coil can be used. This coil is placed in the field of the loop antenna of the radio and a small amount of coupling then exists between the two. The detuning effect is small because of the loose coupling and a high grade job of alignment is performed.

Some receivers of this type have a 10 megohm resistance in the grid return lead. Theoretically the high resistance is supposed to prevent overloading and to limit the plate and screen currents when the input signal becomes too high. However, when the tube runs into grid current it also starts to act as a detector and non-linear amplification results—in short, distortion is produced in the stage. Also, the operation of the set may become erratic until the charge can leak off the grid, causing blocking of the tube. To limit this effect, it has been found satisfactory to take a small bias cell of the 1.5 volt type and connect it in series with the grid return and a 1 megohm resistance. This lower value allows stability to be obtained and better performance is secured.

The same thing goes, too, for sets such as the General Electric GD-60 which uses a grid resistance in the audio grid circuit that sometimes causes blocking, especially

with tubes that are usable but have a little gas in them. The set mentioned is a straight A.C.-D.C. job.

In cases where the chassis is isolated from the line by a small condenser, intermittent hum is often traceable in receivers of this type, and in the regular A.C.-D.C. varieties, to a bad lead on the condenser. That is, the lead may be poorly soldered at the junction with the chassis, at the negative bus or inside the condenser itself. In some cases, just pushing it down firmly fixes it.

MICROPHONIC HOWL

In cases of acoustic howl, where when you rap the chassis the whole thing goes up in a howl, you can isolate the trouble by the stage-to-stage method. The 1H5 is very often a critical tube from the standpoint of microphonics. If it is suspected that the howl is originating in this stage, you can connect a 1 megohm resistor from grid to chassis or negative bus and leave off the grid cap. If the howl persists you know it is in the audio system. You can then disconnect the condenser which goes from the 1H5 plate to the next grid, the 1Q5 or other output tube grid. If the howl stops when this is done the trouble is in the 1H5. If it does not stop, it must be in the output stage.

Using this isolation technique permits a good job to be done, especially when you don't have tubes on hand to fool around with, and don't want to go to the trouble and expense of buying new ones for test purposes. In some cases the howl can be cut down a bit by using a slight amount of rubber tape or ordinary friction tape on the base of the tube—between tube and chassis. This doesn't always work but it is worth a try.

When replacing volume controls, if the diode load is the volume control resistance, avoid using too high a value. As a maximum it should be 1 megohm and generally is best if between 150,000 and 500,000 ohms. Too high a value causes the detector to pass only the signal peaks, with a loss of quality.

In some sets the I.F. will oscillate weakly if alignment is carried out accurately and

(Continued on page 563)

HUM IN P.A. INSTALLATIONS

WITH the growing understanding of high fidelity and its advantages, better amplifiers are coming into use in P.A. systems. No longer is the user satisfied with a cheap job. This is particularly the case in concert halls, where the quality of reproduction is the most important consideration in choosing an amplifier.

The improved low-frequency reproduction afforded by such apparatus brings the serviceman an additional problem—the problem of hum. Precautions that were unnecessary with older amplifiers cannot be omitted, if the hum level is to be kept to an inaudible level. Features that previously had no effect on the hum now become very important.

It is essential, with the low-level microphones often used, that the continuity of shielding be perfect. Even a break as small as 1 inch in the microphone wire shielding will introduce a serious amount of induction pickup into the system.

The amplifier should in all cases be grounded. The ground should be a low-resistance lead to a good earth connection. Often an apparent ground is not a ground, and the chassis is left floating a fraction of a volt away from ground at audio frequencies.

The selection of tubes is important. Many tubes suited for radio use are too noisy for public address work. The construction

of the tube heater structure has much to do with the amount of hum generated in the amplifier. Fortunately tube manufacturers have been keeping up in this respect, and tube structure has been improved. Numbers of non-microphonic types have been put out for pre-amplifier use. The serviceman will be well advised to try several tubes of the same type, especially in the first stages of an amplifier.

Where power is supplied by some of the smaller lighting plants, the waveform of the 60-cycle supply may be particularly good. High-order harmonics in the supply many times may cause puzzling inductive effects or singing. Careful input shielding and grounding takes care of such troubles.

SERVICING NOTES

Trouble in

. . . . PHILCO 116X, 116B

Motorboating, oscillation, fading and occasionally total inoperation are frequent complaints with these models, which are often caused by failure of the same component. A 4-section electrolytic tubular block is employed for bypassing various circuits. Due to loss in capacity or intermittent internal contact, which may be classed as an open-circuit, the symptoms mentioned above are encountered. A 1-mf. section bypasses the first A.F. screen-grid circuit, failure of which produces weak, unstable, motorboating reproduction. Oscillation and total inoperation or the condition wherein only one or two powerful local stations are received at incorrect points on the broadcast band, is the result of an open-circuited 2-mf. R.F., I.F., or 1st-detector screen-grid bypass section, and a faulty 1-mf. oscillator plate bypass section.

Although a new bypass block may be installed when one or more sections are found defective, individual condensers may be utilized to effect a repair. Bridging the suspected section with a unit of the correct capacity is the simplest method of determining the faulty section.

Very weak, choked reproduction with normal shadowgraph action, indicating that the trouble lies with the A.F. amplifier, is due to an open-circuited 1-meg. carbon resistor in the first A.F. screen-grid circuit, which fact, of course, will be immediately manifested by lack of screen-grid voltage on that tube. It is only that the symptom is not unlike output-tube bias difficulty that it is mentioned at all, to save time.

A complaint occasionally encountered with these receivers is the condition wherein reception is obtained for only a minute or two after the set is turned on, after which operation ceases and the shadow indication widens out. When a finger is momentarily placed upon the control-grid of the 77 1st-detector, recovery is had for a few moments. This is due to an open-circuited gridleak for this stage, a 2-meg. unit mounted on a bracket in front of the 1st-detector.

. . . . MAJESTIC 300

On the Majestic Model 300, I had a tube burn-out. It was a special tube, type 2S in the 2nd-detector stage. I substituted a type 24A and grounded the grid of the tube to the chassis with perfect results. The customer is satisfied with the new tube, and doesn't want exact replacement now.

WALTER T. STEVENSON,
Fort Riley, Kansas.

. . . . TRUETONE MODEL D-715

Intermittent Service-Cutting Off when tilting. Space and adjust throwout switch contact points back of push button tuning motor so that contact is made only while motor is in operation. Bendix button in motor does not draw back into motor sufficiently to release contact points, but appears to do so.

WALTER REYNOLDS, JR.,
Hattiesburg, Mississippi.

. . . . PHILCO 53 AND 59

Watch for shorted filter condenser caused

by pressure of I.F. trimmer condenser plate being pressed against terminal during adjustment, causing short to ground.

WILLIAM ANDERSON,
Bronx, New York.

. . . . BUICK SONOMATIC

If you can tune this set with the push buttons but not with the manual control when the set is on, look for a broken spring on the right hand side of the condenser push button assembly. Look real close because the spring is small and is very easily missed. This spring is supposed to kick back the rocker arm with the return of the push button when it is used. This rocker

ATTENTION SERVICEMEN!

Do you have any Servicing Notes available which you would like to bring to the attention of the readers of *Radio-Craft*? If so, send them along and if they are published a one year's subscription to *Radio-Craft* will be awarded you.

arm has a switch on the right side of it, which it opens and closes each time it swings back and forth. The switch in turn controls a relay which releases the manual control from the condenser when the push buttons are used. If the spring is broken the rocker arm does not return back to the position in which it should be and the switch on the side stays closed. Therefore, the manual control is released from the condenser and you are unable to tune with it. To remedy put a new spring in the set. In order to do this the condenser and push button assembly must be pulled out of the set.

MICHAEL YURKOVICH,
Highland Park, Mich.

. . . . PHILCO 112X

This receiver when playing would play fine for periods of 15 to 30 minutes after which it would fade and the customer would have to turn the dial to catch up with the station. Tubes found O.K. and upon examination and checking for voltage it also was as per voltage measurement by Philco. But the R-51 (value is 15,000 ohm 5 watt) unit, after disconnecting, was found to measure 2000 ohms and this is a big change in resistance. Replace with a new unit 15,000 ohms, but make sure you replace with a wire-wound resistor instead of carbon. Also replace C-42 with any reliable condenser rated .02 mfd. 600 volts. This set is playing fine and the customer is more than satisfied.

STEPEN M. SKOVVAN,
N. S. Pittsburgh, Pa.

. . . . SLIPPING DIAL CORDS

On many of the nameless variety of receivers using cloth dial cords driven by two or three turns around a quarter inch drive shaft, a great deal of trouble has been experienced—namely slippage on this drive shaft as well as slipping off of the large pulley when the large pulley is near it, stops at either end.

A good permanent remedy is to remove the old cable and then install a three-quarter

inch outside diameter by one-quarter inside diameter idler pulley (with a narrow groove) on the one-quarter inch drive shaft by soldering. Take care to properly line up the two pulleys so that the cord runs true. Rewind with large dial cord using same method as originally used, but make only half turn around new driving surface. Pull cord fairly tight and cover with resin. Obviously the knob to dial ratio is about three times faster, but is acceptable.

BADGER & CASKEY,
Indianapolis, Ind.

. . . . STEWART-WARNER 1942 MODELS —SPEAKER PARTS

Due to the parts shortage, it has been necessary to obtain speakers for Stewart-Warner 1942 Radio Receivers from several companies. Speakers bearing the same part number are directly interchangeable, regardless of supplier, but the service parts such as cones and output transformers for a given speaker are not interchangeable with those for a similar speaker obtained from a different manufacturer. Some changes of this kind were made after the Service Manuals were printed, thus all the correct speaker parts are not listed in the parts lists.

Before ordering cone and voice coils or output transformers for the Models listed below, check the prefix letter before the number stamped on the speaker frame. The prefixes commonly used are "R," "M," "U," "C," and "CR." If in doubt as to the proper part number for a cone or output transformer, include the part number of the speaker on the other and

BE SURE TO SHOW THE PREFIX

The following table shows the receiver models which used more than one type of speaker and the service parts for the various speakers:

Receiver Model	Speaker Number	Order Cone And Voice Coil Number	Order Output Number
206DAS	/ R-500918		
206DHS	/ or	R-500331	R-500921
206DCS	/ R-500920		
206EAS	/ O-500918		
206EBS	/ or	O-501475	O-501474
206ECS	/ O-500920		
208BK	/ M-501245	M-501305	M-501304
208CK	/*CR-501245	CR-501247	CR-501246
12-4D1	R-500886	R-500913	R-500912
	*CR-500886	CR-502011	CR-502012

*On some "CR" speakers the prefix is not shown, but the speaker can be identified as such by the distinctive olive-gray color of the frame.

. . . . TRUETONE D920

Hum resembling filter hum during operation. Filter condensers test O.K.

Change the volume control. A defective one will cause trouble easily mistaken for filter hum.

HENRY D. MORSE,
Homer, N. Y.

. . . . CORONADO AUTO RADIO NO MODEL NUMBER

Oscillation and distortion with volume turned on from medium to loud.

Look for open .001 condenser from plate of 45 tube to ground.

W. L. DOUD,
Mount Pleasant, Mich.

INDUSTRIAL MUSIC IS SPUR TO PRODUCTION

MUSIC electronically distributed to workers in industry is becoming increasingly common. Not only is the Public Address apparatus useful in building morale by bringing music to the work bench, it is used for "pep" talks and messages to the whole factory by company officials or others. (See "Plant Broadcasting" in the November, 1942, issue of *Radio-Craft*.) In time of emergency, the value of such a system could not be over-estimated.

The idea of industrial music is not new. Westinghouse claims to be the pioneer in the field, having started in 1925. The first installation was the result of an accident. Tests were carried out on loudspeakers near an assembly belt. After the tests were completed, the workers asked that the music be continued, and it was. Recently a number of factors have contributed to its spread. Chief among these have been attempts to increase production and morale as a means of furthering the war effort, and the installation of sound systems in factories for communication and plant directive purposes. In England, such installations are required by law, as a means of directing the workers during air-raid alarms.

While industrial music has become well established, exact information as to its benefits has lagged behind. Management and labor agree on its value, companies who have installed systems report enthusiastically, but no one has come out with any figures on how much music helps in the factory. Modern personnel departments require scientific figures as exact as those needed by the engineering section.

This important question formed the subject of an investigation by the Stevens Institute of Technology (Hoboken, N. J.). Using the production rate as an index, figures covering the daily output with and without music were taken. These were then made up into the graphs shown on this page, for the first time demonstrating the value of plant broadcasting quantitatively as well as qualitatively.

CONTROLLED EXPERIMENT

Every effort was made to control the experiments so that outside influences would not affect the production result. Therefore tests were not made on days showing significant weather changes, or when there was any plant change (machine arrangement, repair work, etc.), or during periods of other than normal labor turnover or labor management quarrel. Thus the results may be taken as showing definitely the effect of music on production.

These effects are graphically shown in Fig. 1*, which shows a typical day before music was installed, as compared with a typical day after the plant broadcast system started working. The dotted lines refer to periods before, and the solid lines, after, broadcasting of music to the workers.

It will be noted that before music was introduced, there was a deep slump just before three o'clock. Installation of the music system changed this to a peak. The output as calculated per quarter-hour is erratic in each case, but the average (shown by the dotted and solid straight lines) indicates a net gain of more than 6%.

The curves of Fig. 2 compare the output of two typical weeks, one before and one after the P. A. music system was put into operation. Again the results show a notable gain for King Music, the difference between the two weeks amounting to 11%.

CURE FOR ABSENTEEISM

A different approach to the same problem was made in Fig. 3. In the factory studied, workers were on piece work, and when

tired went home early. The graph shows dramatically the reduction in lost man-hours after the introduction of plant music.

In the same plant, Monday morning absenteeism was a problem. Fig. 4 was based on four average Monday mornings before, and four after, the introduction of plant music. The figure tells its own story.

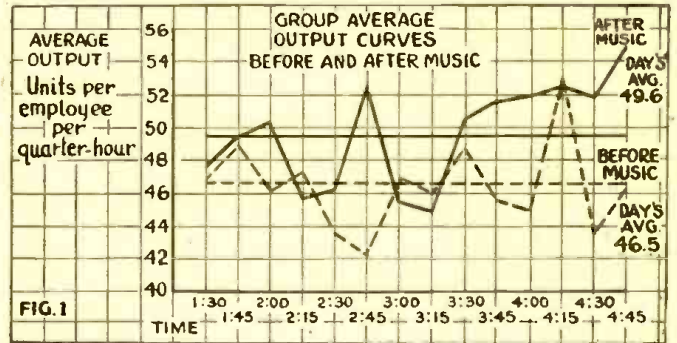

The question of programming was also investigated. Not enough work was done to result in definite conclusions, but the results tend to show that programs specially designed for industrial use produce much better results than mere hit-or-miss music. In one case where the installation of music resulted in an 8% increase in production, the introduction of a planned program of numbers

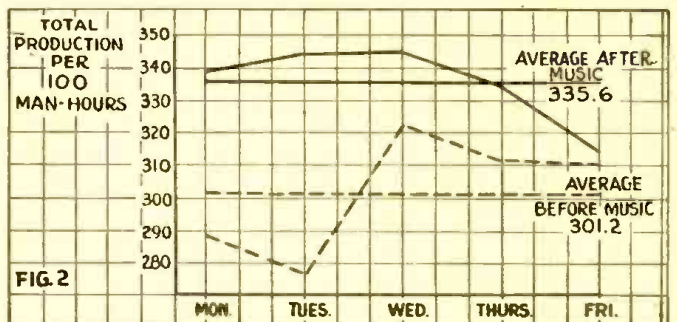

especially arranged and recorded for industrial use—handled by a director of considerable skill and experience—boosted this increase to 15%.

These graphs hold a deeper significance than is expressed in the bare figures of increased production and fewer lost man-hours. They speak eloquently of a general increase in the satisfaction of the worker with his job, a different attitude toward the factory, an all-around better adjustment to life, which must carry over into the hours spent outside the plant. The Institute carried out its investigations with the object of expressing the value of industrial music in exact figures. It was thoroughly successful in this. The very same figures, however, point out all the

(Continued on page 564)

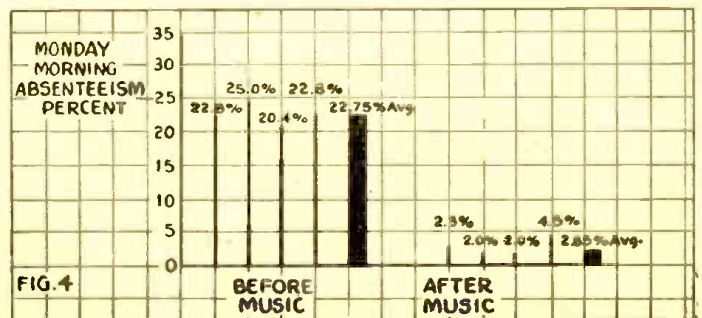
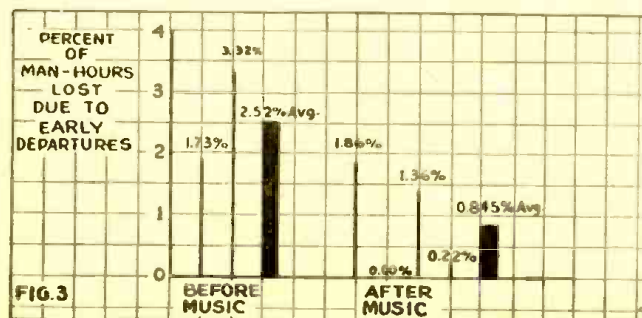

PRACTICAL AUDIO AMPLIFIER THEORY

By TED POWELL

PART V—CIRCUIT WIRING AND COMPONENT ARRANGEMENT

THE spacing and arrangement of circuit components and wiring may often have more effect upon circuit performance than shielding and by-passing. Generally speaking, a generous-sized chassis is advisable so that over-crowding and excessive inter-stage capacity, conduction, radiation and induction coupling is not set up. Obstinate cases of oscillation and hum pick-up can sometimes be cured by simply spreading out and shifting some of the circuit wiring and components.

An old trick used to determine the optimum arrangement of transformers and chokes for minimum coupling is to energize a winding of one of the units with a high-frequency buzzer and listen in on a pair of earphones tied in on another unit's winding. The units are rotated and shifted about till the weakest induction signal is heard in the phones. It can be safely assumed that under these conditions, minimum total coupling exists between the audio units at ordinary audio frequencies.

Fancy lacing and square-corner arrangement of circuit wiring, while pretty to the eye, may be a source of trouble where cir-

All soldered joints must be clean, tight and hot-soldered. Otherwise oxidation-resistance joints may be created which will cause rectification and loss effects and bring on distortion, loss of gain and oscillation troubles which will be difficult to trace.

In this concluding section of his series on audio amplification, Mr. Powell cleans up some of the detail and presents one or two interesting new ideas. A new series of radio articles by the same author may be expected in an early issue.

TRANSPOSING A CIRCUIT

This brings us to the simple circuiting idea used in the phono amplifier presented in this article, the transposition of a p.p. circuit. It may be old stuff but is presented here for whatever it may be worth.

As was already mentioned, the location and distribution of circuit components about a chassis has an important bearing upon a circuit's behavior as to uni-stage or over-all oscillation of various types and hum and noise pick-up, especially in the case of hi-gain circuits. Electrostatic, magnetic, radiation and conduction coupling constants and the phase relationships between these "couples" or "linkages" may be radically altered by the shifting about of circuit components, shielding and wiring. No set of foolproof formulas can be set up for these factors because the complexities defy mathematical analysis such as it is today, even when rough approximation methods are resorted to (equivalent parameters). Even power transmission system design problems, especially under transient conditions, are being solved today with the aid of miniature "dummy" circuits rather than by purely mathematical means.

The idea involved in transposing p.p. circuits lies in the attempt to alter some of the coupling constants and to cancel out some of the couples by criss-crossing the circuiting and thus reducing some of the evils resulting from the coupling constants. Electronically the transposed circuit is the same as the straight-wired circuit, of course, with only some stray constants altered. It is reasonable to suppose that coupling constants might be altered so that they are increased rather than decreased by the transposition.

This transposition was not tested in a hi-gain circuit and neither has it been checked with a cathode-ray outfit. Since it costs nothing in the way of materials or parts, the experimenter or "ham" has nothing to lose in trying it out. Oscilloscope tests would determine at what points in the amplifier transposition would produce the best results, if any, or if some sort of unsymmetrical or unbalanced transposition system would be more effective.

PARASITIC OSCILLATIONS

This transposition idea might be applied to p.p.-parallel or parallel power amplifier

tube circuits which often suffer from a trouble known as "parasitics" or "parasitic oscillation." These parasitics exist in several types, or more correctly, in several varieties of two or three types. They are a sort of a reflex circuit action in that audio, R.F. or even rectifier tubes in a paralleled, p.p. or p.p.-paralleled circuit sometimes oscillate at higher R.F. levels because of stray circuit constants which may be either lumped or distributed parameters or both. More than one parasitic may possibly exist in one circuit at the same time. This phenomenon causes a tube to cease acting as a normal amplifier and the result may be distortion, excessive plate current, hums, "birdies," whistles, "tweets" and generally erratic circuit behavior. These manifestations are often confused with other circuit symptoms elsewhere in the amplifier circuits. The parasitic may be a simple regeneration type of oscillation, a "parallel" type of oscillation and—in the case of paralleled tubes—a peculiar type of intra-tube oscillation which radio engineers analyze as a regenerative T.P.T.G. type of oscillation.

The writer, however, has a suspicion that the oscillation in the case of paralleled tubes may be a high-frequency form of electronic "hunting" due to inequalities and variables in tube and circuiting constants (which are supposed to trigger and start off standard oscillators) which is similar to the electro-mechanical hunting common to certain generators or synchronous motor-generator combinations in power work. The fact that only a single resistor inserted between the grids of two paralleled tubes is sufficient to stop this type of oscillation might lend some support to such a theory. It may also help explain oscillation troubles in the case of paralleled rectifier tubes.

The theoretically possible benefits from criss-crossing such power tube circuits can

(Continued on page 564)

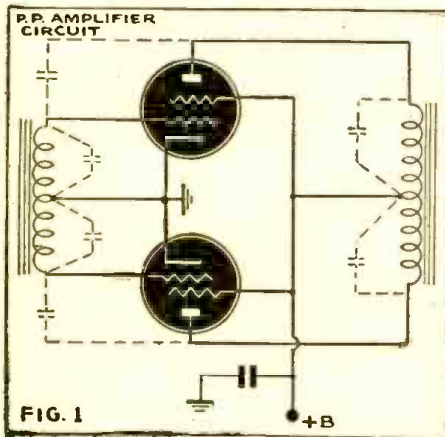

Parasitic oscillation circuits in a push-pull amplifier. The dotted condensers are tube capacities and distributed capacities across transformer windings.

cuit performance is concerned. Such frills increase inter-stage coupling constants and may bring on hum and oscillation bugs. Short, straight, direct, space and non-symmetrical wiring runs are advisable, especially in the case of hi-gain amplifier circuits.

It is also advisable to bring all the ground return leads of any single stage back directly to one common ground at the ground end of the tube's cathode resistor. This will eliminate criss-crossed chassis return currents and will eliminate a conduction coupling constant between stages. Furthermore, the chassis has appreciable resistance and impedance and the appreciable potential gradients existing in it can be picked by the tube amplifier circuits, amplified and passed on as a cross-modulation with the signal. The less chassis currents, the less hum and oscillation sources present—the less trouble that will result from these two headaches, especially in the case of low-level circuits.

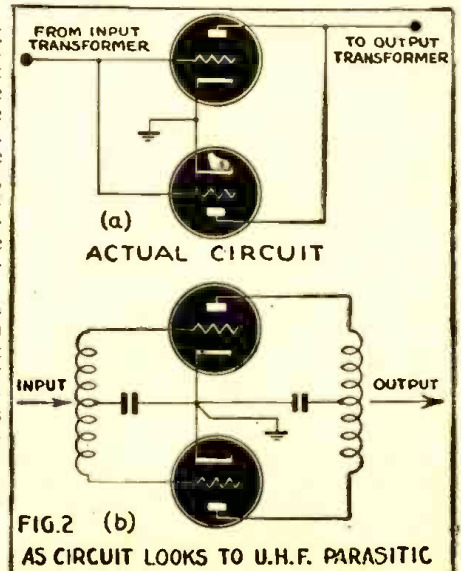

How parallel-connected tubes may give rise to parasitic oscillations.

A RECORDING AMPLIFIER

This A.C.-D.C. amplifier, which the owner has used successfully for recording, may fill a pressing need in the present parts shortage.

By ROBERT J. NISSEN

IN recent years the increased interest in instantaneous recording equipment and its associated fields, has been the cause for marked improvement and rapid development of high fidelity recorders and phonographs. The design of most of this equipment has been with a view to producing an inexpensive, but dependable unit, without sacrificing any of the qualities of the more expensive recorders of past years.

It is the purpose of this article to describe an amplifier with suitable characteristics, which may be used for both public address and recording. Before describing this amplifier, which can be built for less than ten dollars, it is worthwhile to explain why such a unit must be designed primarily for recording. For recording the variation of the impedance of the cutting head load cannot be neglected. For instance, a cutter rated at 15 ohms at 1000 C.P.S. was found to have three ohms at 100 C.P.S. and twenty ohms at 3000 C.P.S. This variation will be reflected into the output transformer's primary impedance and will result in decreased output and high second harmonic distortion.

The design engineer can overcome this fault by doing one of four things.

1. Employ inverse feedback.
2. Use a single triode output.
3. Design a push-pull output stage using triode tubes.
4. Design a push-pull output stage using beam tubes.

The first one reduces the gain and sometimes has parasites which are difficult to eliminate. The second remedy will give second harmonic distortion on the low frequencies. The third generally runs into great expense. The last one is chosen because it is believed that it will come closest to fulfilling all these requirements.

DESIGN OF THE AMPLIFIER

This amplifier is designed for 110 volt, A.C.-D.C. operation. A mike and phone input is provided. The novel arrangement of the 6C8-G input stage permits mixing of phonograph and microphone at will.

The first triode section of the 6C8-G is used as a resistance-coupled amplifier. The signal is amplified in this section, shifted in phase 180°, and coupled to one of the 25L6-GT tubes. The other 25L6-GT in the

push-pull circuit needs a signal 180° out of phase with the signal fed to the first 25L6-GT tube. This means that the signal must be passed through the second triode section of the 6C8G tube for this purpose. This second triode section does this phase inversion (180° change), but its amplification is nullified by reduction of the signal in the same proportion as the tube amplification factor. An effective tone control is also incorporated in the grid circuit of the power output tubes.

Since the plate current for the two 25L6-GT's is obtained directly from the input side of the filter, a larger filter condenser of 25 mfd. is used at this point. For the screen grids of these tubes and for the plate voltage of the first and second stage, additional filter action is provided by a small choke and another 10 mfd. electrolytic condenser.

This amplifier has proved itself to be a versatile unit, and has many uses other than those specified.

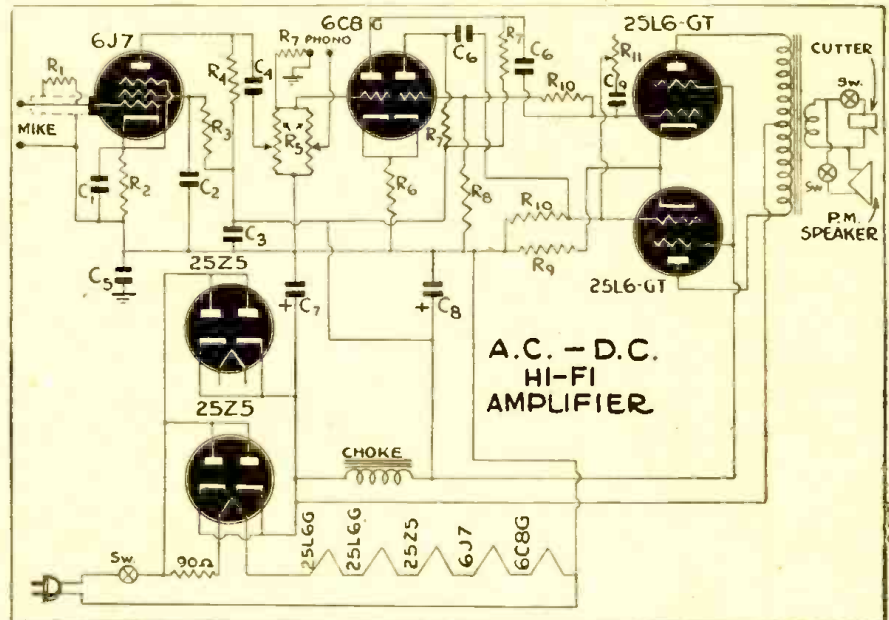

Parts List for Amplifier

TUBES

- 1-6J7
- 1-6C8G
- 2-25L6-GT
- 2-25Z5

RESISTORS

- R1-5 megs. 1/2 watt
- R2-5500 ohms 1 watt
- R3-2.7 megs. 1 watt
- R4-1/2 meg. 1 watt
- R5-500,000 ohm Volume controls
- R6-3000 ohms 2 watt
- R7-100,000 ohms 1 watt
- R8-9000 ohms 1 watt
- R9-75 ohms 5 watt
- R10-250,000 ohms 1 watt

R11-500,000 ohms tone control

CONDENSERS

- C1-2 mfd. 150 vv.
- C2-.02 mfd. 150 vv.
- C3-8 mfd. 150 vv.
- C4-.0015 mfd. 500 vv.
- C5-5 mfd. 200 vv.
- C6-.01 mfd. 500 vv.
- C7-25 mfd. 150 vv.
- C8-10 mfd. 150 vv.
- C9-.005 mfd. 150 vv.

MISCELLANEOUS

- Universal output transformer matched to two 25L6-GT tubes
- Small A.C.-D.C. choke

MAGNETOSTRICTION OSCILLATORS

MAGNETOSTRICTION is an effect noticed to a varying degree in most ferrous (iron-like) metals. When a piece of iron is magnetized its length increases or decreases very slightly. The change in length depends upon the amount of magnetization.

While this property is often a disadvantage it is usually turned to good account by application in some oscillators. These oscillators are constructed somewhat like the electrically driven tuning forks, for frequency control. A steel bar of proper size to resonate mechanically at the desired frequency is used. Connected to it is a

vacuum tube circuit to control the magnetizing of the bar.

When the bar is magnetized it induces a small E.M.F. in a coil. This induced current is fed back to the tube circuit. Thus the oscillation is sustained.

Transmitters using magnetostrictive type oscillators are used as sources of high frequency under-water sound waves in echo-depth sounding devices. The small movements of a steel structure, due to alternating current magnetization, cause sound waves to be propagated from a ship through the water to the bottom of the sea. They are reflected back to the ship where a similar

device is used to reconvert the vibrations into weak alternating currents again. The time between the transmitted and the received impulses can be interpreted in terms of the distance to the bottom.

COMMON MANIFESTATION

The audible sound developed by transformer cores is one example of the disadvantages of magnetostriction. Ofttimes, even when firmly clamped, small changes in dimensions of the core pieces can cause appreciable amounts of hum. — R.S.G.B. Bulletin, London

RESONANT COILS AND REACTING CONDENSERS

By FRED SHUNAMAN

EVERY serviceman knows he can cut down the current in a circuit by inserting a "choke coil," and that if the coil is so made that the iron coil can be slipped in and out, the amount of reduction can be varied over a wide range.

It is almost as well known that a condenser can also be inserted in a circuit to cut down current flow. Inductors and condensers, then, can be used instead of resistors.

The writer first learned that condensers

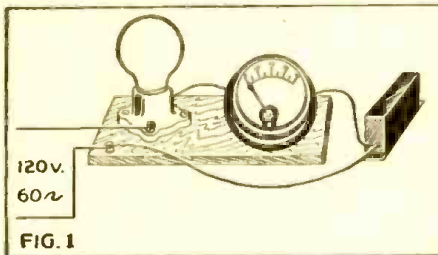

or inductors are not always resistor substitutes while adapting a 110-volt electric clock to operate on 220 volts. A small tubular condenser was fitted inside the case, the size being chosen to give a voltage of exactly 110 across the clock. Everything worked beautifully, with one single exception. When the plug in the wall socket was reversed, the clock motor worked at exactly double speed! Plugged in one way it was normal, but turning the plug around invariably caused two hours to be registered every hour. The attempt was abandoned and the motor coil rewound.

Incidentally, when the voltage across the clock was 110, the condenser had a little more than 180 volts across it—all this from a line where the voltage never reached 220. Obviously a condenser does things to a circuit that a resistor never can!

CALCULATING IMPEDANCES

If we want to use condensers and chokes to control current we will have to find out how to calculate them. A glance at the nearest radio manual shows us that a condenser has a "reactance" to the flow of alternating current amounting to

$$\frac{1}{2\pi fC}$$

ohms, and that the reactance of a coil is $2\pi fL$ ohms. The units of inductance and capacity here are the Henry and Farad respectively. To use the common microfarad, the practice is to use

$$\frac{1,000,000}{2\pi fC}$$

ohms and read C in microfarads. f is the frequency in cycles.

There are three interesting things about this formula. The term "reactance" denotes definitely that the coil's or condenser's opposition to the flow of current is not resistance. It reminds us of Lenz' Law, which attributes a very positive reaction to a coil when acted upon by an electromotive force.

Second, the reactance varies directly with frequency, increasing for a coil and de-

creasing for a condenser. This is what our investigations of the previous articles would have led us to expect.

Third, we again run into the number 2π , or 6.28, the ratio between the radius of a circle and its diameter. (Since practically all the electric current in the United States is on 60 cycles, we can combine the number, $2\pi f$ —written ω —and write it 377.)

A REACTANCE EXPERIMENT

A setup like that of Fig. 1 will help to find out a little more about coils and condensers. A number of lamps of various sizes, the transformer used in former experiments, a condenser of approximately 5 mfd. capacity, and a 0-1 ampere A.C. meter (an old R.F. meter) were lined up so that either coil or condenser or both could be hooked up and currents and voltages measured.

The condenser was first tried out, with a 15-watt lamp in series with it. Voltage across the condenser was 56, across the lamp, 104. Total line voltage, 120. This in spite of the plain statements of arithmetic, which insists that the sum of 104 and 56 should be 160.

But reactance is not resistance, and we cannot get the total impedance of the circuit by a simple addition. We must lay out a little diagram like that of Fig. 2. Lay

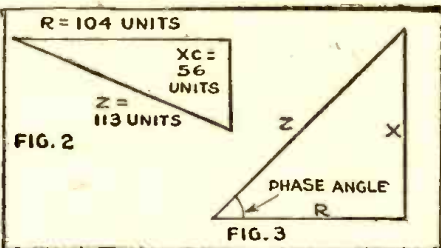

down a line 104 units long (any convenient unit, millimeters or sixteenths of an inch). This represents the resistance voltage drop. Lay down another, as shown, 56 units long, for the reactance voltage drop (X_c , or condenser reactance, in the diagram). Now draw the line Z, and measure it. Do not expect to get 100% accurate results—there are a number of factors here we can't measure with this setup. There is a certain amount of resistance in the condenser, which we are calling pure reactance. Putting the voltmeter across any one of these units has some slight effect, especially with small condensers and large coils. In the experiment mentioned the final result was 113 volts instead of 120. If you are as

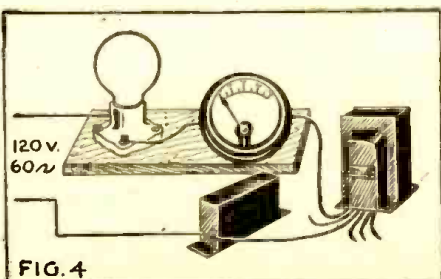

close as that, or even as close as 10%, you can consider yourself lucky.

Remembering that a capacity in the circuit tends to put the voltage and current 90 degrees out of phase, we begin to see a little light. A resistor opposes the flow of current directly—each electron has to push its way ahead through the reluctant atomic systems in its path. Speaking

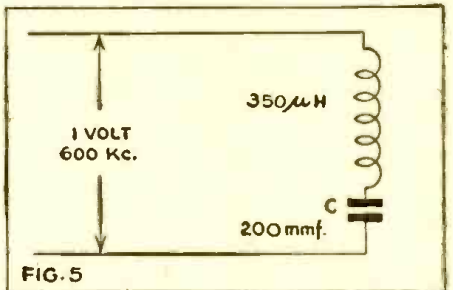

mathematically—or geometrically—it acts 180 degrees in opposition to the current. A coil or condenser, however, tries to pull off at a 90-degree angle to the current, and it is necessary to so represent it in any calculation. (This 90-degree sidewise pull is mathematical only—the electrons are not pulled sidewise in the wire.)

It has already been pointed out that in a purely resistive circuit, the phase angle is zero, and that in a purely reactive circuit it is 90 degrees. Let us take a case where we have exactly the same amount of reactance and resistance. We would expect a 45-degree phase angle, and we measure that angle in our diagram, (Fig. 3). Since the term "phase angle" refers to the ratio of the effects of reactance and resistance, or the ratio between the length of the two lines representing them, we can find it by measuring the angle between the "Z" and "R" lines in the diagram.

HOW INDUCTORS REACT

Now to see whether an inductor will act like a condenser in reverse, as it has done up to the present. For this experiment the transformer of the previous articles was brought out, the primary being used. A big, low-resistance choke would have been better, as using the primary for an inductor introduced considerable resistance and the inductance dropped rapidly as the current increased. Nothing else was at hand, and the transformer was used, with all its disadvantages.

With the 100-watt lamp in circuit, the reactance of the transformer was about 1200 ohms, 0.1 ampere at 120 volts being registered on the meter. The current through the condenser under the same conditions was about 0.22 ampere, showing a reactance of 540 ohms. The next step was to hook inductor, condenser and lamp all in series, giving us the circuit of Fig. 4.

Things begin to happen. The lamp, which up to now had shown no sign of life, lights up to more than half brilliancy, and the meter shows 0.54 ampere. The voltmeter shows 250 volts across the condenser, (Continued on page 565)

A MIDGET OSCILLATOR FOR CODE PRACTICE

By DAVID GNESSIN

Code oscillators have long been victims of raw beginners on their first construction job. That is why it comes almost as a surprise to see one which is a thing of beauty and an object of good engineering. Mr. Gnessin proves that care and workmanship pay the best dividends on the simplest projects.

ALTHOUGH there are many uses for an audio oscillator, e.g., signal-generator, tuning pitch, attention signal, etc., probably its most popular use today is that of code oscillator for telegraph sending and receiving practice. The unit described here is designed for just such use. It is readily portable, weighing little over one pound complete, and is just over three inches square. The power cord is wound around the box when not in use. In this manner, with the tube removed from the socket the entire unit may be carried in the overcoat pocket.

At the end of the construction article the theory of operation will be summarized. The oscillator is constructed on a chassis made of an old wooden 2 or 5 pound cheese box. After estimating the size required by temporarily placing the transformers and filter condenser in one end of the box, the box is shortened to where it can just accommodate all components comfortably. Then take the end from the sawed-off part and join it to the chassis end. This should make a box just over three inches in each dimension.

Mark off a circle in the center of the top of the chassis to permit the loktal tube base to show through. Then drill small holes around the periphery of the circle. Cut out and sandpaper the hole. A broom-stick wrapped with sandpaper makes a fine finishing tool. Mark and drill socket mounting holes.

Without mounting the two transformers and filter condenser, move them around like chessmen until you find the most convenient placement for each part. Mark and drill the mounting holes for them. Then drill a hole for the power cord, then two pairs of holes for the phones and key jacks. Then sandpaper the chassis smooth and paint. You'll probably be impatient to build the oscillator; but it will pay to paint the chassis first because painting the finished oscillator is messy. After permitting the first coat to dry hard, finish with black enamel or crackle finish.

WIRING THE CIRCUIT

After the chassis dries out completely, mount the loktal socket. Check again to make certain where each component goes. Then, don't mount them! Leave the transformers and condenser outside and connect long leads to them. This is necessary because it is impossible to build, solder and test the oscillator in the confined space when the components are already mounted.

Wire the socket, connecting the other elements, using the base diagram shown. The cathode resistor may be bolted to the side of the box, if desired. This will avoid vibrating and shorting wires.

After all connections are made, check carefully. Test for continuity and correct terminal connections with an ohmmeter, if

one is available. Then plug in the 7F7 tube, plug in to A.C. hook up phones and key and test. The phone and key terminals may be reversed without damage. There may be a difference in tone in that case. A small typed paper name plate may be pasted above the jacks. A piece of scotch tape over the name plate will protect it.

If there is no clear oscillating note when the key is depressed, reverse the primary leads in the audio transformer. This will give a musical note. To change pitch, vary the resistance of the cathode resistor.

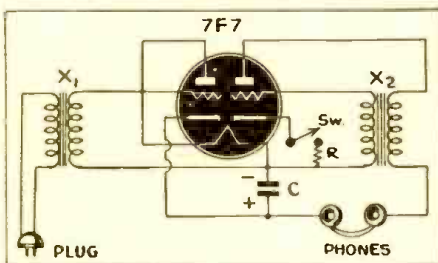

The greatest simplicity consistent with good design marks this oscillator.

After testing oscillator the components may be bolted in place beneath the chassis. Now the long connecting leads may be shortened to proper length or they may be tucked in as desired. The oscillator is now complete.

THEORY OF THE OSCILLATOR

The 7F7 is a loktal, single-ended dual-purpose tube containing two independent triodes in one envelope. Consider the left hand triode first, as shown in the schematic diagram:

The filament transformer (this should be as small as possible; an output transformer giving 6 volts out of the smaller winding is satisfactory) is connected from power cord to the tube filament. No "on-off" switch is shown, although one may easily be incorporated if desired. The same six volts output provides the D.C. high-voltage supply. (Yes; in this case the "high-voltage" is 6 volts D.C.)

The output of the filament transformer goes to the plate and grid connected together, forming a diode half-wave rectifier. The direct current is taken off the rectifier cathode. This is filtered by the 25 mfd. condenser. This is a competent filter. The D.C. passes through the headphones to the primary of the audio transformer.

Now, consider the right hand triode in the diagram. The grid winding of the audio transformer constitutes the tuned grid circuit. The feed-back from the plate circuit causes oscillation. Varying the cathode resistor varies grid bias, changing the oscillation frequency. The audio transformer should be as small as possible. A small output transformer with the secondary replaced by as many turns of fine wire as it will hold will prove an efficient substitute.

The 6 volts of D.C. provides a good clear signal in a pair of headphones. Two pairs of phones in series will permit two persons to hear simultaneously. Some phones will give greater response when connected in parallel. Two pairs of phone jacks may be built in to the oscillator if desired. If they are hooked up in parallel, one or both pairs may be used.

One outstanding feature of this oscillator is its safety feature. The only exposed terminals have 6 volts at low current. The entire oscillator is isolated from the A.C. power line by the filament transformer. Thus it is impossible to receive a shock even if the oscillator is connected to ground. Those who have been "hit" when using AC-D.C. oscillators will appreciate this feature.

List of Parts

- X₁—Filament transformer (6.3 v.)
- X₂—Audio transformer (any ratio)
- Sw—Telegraph key
- R—2000 ohm (1 watt) resistor
- C—25 mfd. 25 volt condenser
- PJ—4 phone pin jacks
- 7F7—Vacuum tube
- 1 loktal socket
- 9 small bolts and nuts
- 1 AC power plug
- Wire, solder, etc.
- Radio headphones, 1 pair (or 2)
- Cheese-box chassis

The oscillator hooked up for use, with speed key and phones. Line disappearing out of the top of picture is the line cord. Note size of the complete oscillator—actually smaller than the "bug" key.

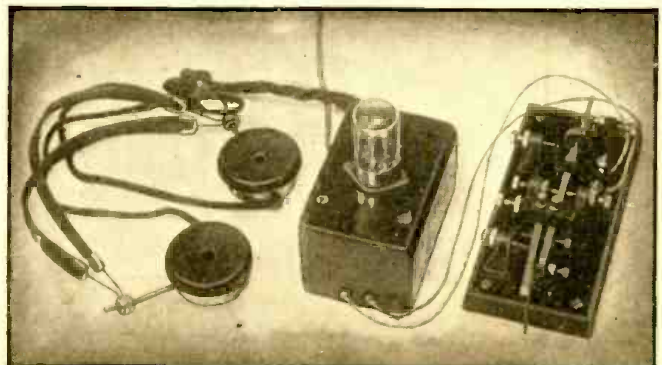

A COMPACT SIX-TUBE BROADCAST RECEIVER

By B. W. EMBREE

THE following circuit diagrams are of an A.C. Superheterodyne covering the standard broadcast band, 540 to 1680 Kc. and employing 5 tubes (or 6 if the builder wishes). The tubes are of the single end type, namely 6SA7 oscillator, 6SK7 I.F. amplifier, 6SQ7 diode detector A.V.C. and 1st audio amplifier, 6F6G output, 5Y4G rectifier, and optional 6U5 tuning indicator. Standard parts are used and the circuit is similar to any number of the later type commercial receivers. It is simple and straightforward and is intended primarily for the younger fellows to start on and study, but I may say that if the parts listed are used the set has plenty of pep and is well worth the time required. Instructions are given for making the dial frame and plate for those who wish to do so.

In wiring the set it is well to keep all leads short and direct as possible, also keep plate and grid leads from running parallel. Most particularly keep the leads from the antenna and oscillator coils short and direct (this is not critical in this circuit but is very necessary in all wave circuits, so it is well to learn this at the start). The diode return lead from 50M ohm resistor 2nd I.F. to volume control should be as short and direct as possible and dressed close to chassis, also the leads of the .01 mfd. condenser from volume control to grid of 6SQ7. The 10 meg. resistor leads should also be as short as possible to prevent hum from creeping into the circuit. The leads of the .01 mfd. condenser between the 6SQ7 plate and 6F6 grid should also be as short as possible. All these precautions should be followed by the beginner. To check results experiment by increasing the length of the leads after you have the set operating and make comparisons.

The dial can very easily be made. Procure three lengths of heavy gauge sheet iron (galvanized No. 16 was used). The material should be 1/2" or more wide, and two lengths 5 1/2" long. The third piece should be about 2 inches longer than the distance that the pointer will travel. This distance will be one-half the circumference of the dial drive pulley. Bend the two 5 1/2" pieces as shown in the diagram (Dial drive-b.), and drill two holes in each of the 3/4" bends to mount them to the chassis. The third piece is left straight and connected to the tops of the upright pieces and serves to strengthen the structure and also as a track for the pointer to slide on. For the dial scale get a piece of double diamond glass cut to the proper size and paint it black with water colors and then paint the dial scale over this in red figures. A pilot lamp back of this makes it very effective. It is well to use a piece of cardboard to make the first scale. If a signal generator is available it will be a very simple matter to mark the scale off, if not it will be necessary to check on known stations until you get the markings.

When the set is assembled and wired it will be necessary to align it. If a signal generator is available this is a simple matter. First check the I.F. transformers by adjusting the trimmers in the top of the cans, the second transformer first and then the first transformer. If a generator is used

connect the leads between ground and stator plates of the variable condenser antenna section. If a generator is not available tune in a weak station and adjust the trimmers in the same order for maximum volume or if the eye is used, for minimum shadow. With this done tune to 1500 Kc. and adjust trimmers on gang, first on oscillator section, and then antenna section, for

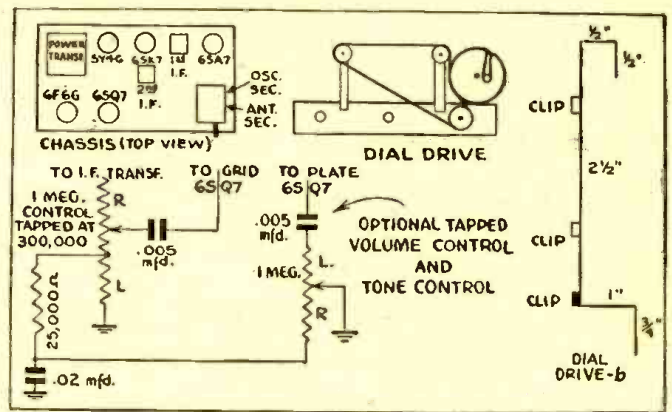

maximum output. Now tune to 600 Kc. and adjust padder for desired frequency. If this padder has to be changed very much it will be necessary to repeat the 1500 Kc. adjustment. I might advise that if the builder uses Meissner I.F. transformers they are peaked at 456 Kc. and very little adjustment will be necessary on the trimmers.

In the circuit I have shown only a standard volume control and tone control. However, if the builder wishes he may use a tapped volume control and tone compensation control. I have shown the required hook-up for this.

Parts List

- L1—Ant. coil Meissner 14-1024 (remove shield)
 - L2—Osc. coil Meissner 14-1033
 - C1, C2, C3, C4—Var. con. 365 mfd. Meissner 21-5214
 - C5—Osc. padder Meissner 22-7005, 175 to 600 mmfd.
 - C6—.001 mfd. 600 volt
 - C7—50 mmfd mica
 - C8, C9—.1 mfd. 400 volt
 - C10, C18—.05 mfd. 400 volt
 - C11—100 mmfd mica
 - C12—250 mmfd. mica
 - C13, C14—.01 mfd. 600 volt
 - C19—.006 mfd. 600 volt
 - C15—25 mfd. 25 volt
 - C16, C17—16 mfd. 450 volt
 - R1—1 meg.
 - R2—20,000 ohms
 - R3—800 ohms
 - R4—15,000 2 watt
 - R5—5 meg.
 - R6—50,000 ohms
 - R7—1 meg. vol. con.
 - R8—10 meg.
 - R9—500,000 ohms
 - R10—500 1 watt
 - R11—500,000 ohms
 - R12—25,000 ohm tone control
- All resistors can be 1/2 watt except where otherwise stated.
- Chassis base 5 1/2 x 10 x 3
 Meissner I.F. input 16-5712
 Meissner I.F. output 16-5714
 Power transformer primary 120, secondary 300-300
 Fil. 5 volt 3 amp.
 Fil. 6.3 volt 2 amp.
 Output transformer 7000 ohm plate resistance
 Speaker with 1000 ohm or higher field coil
 1 ea. 6SA7, 6SK7, 6SQ7, 6F6G, 6U5G, and 5Y4G
 (Continued on page 572)

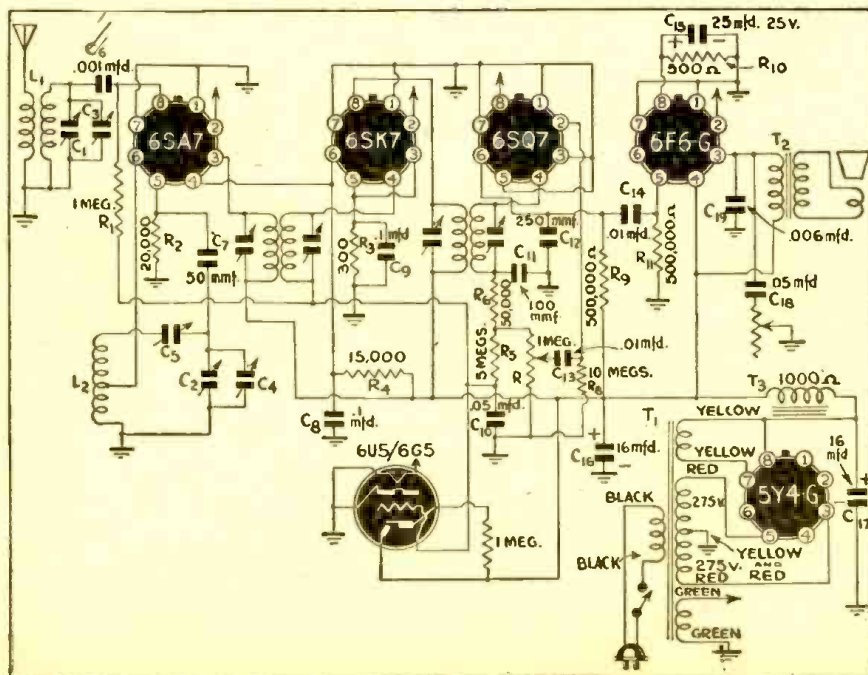

WE ASKED 817 MEN TO NAME THE *Best* RADIO TRAINING BOOK THEY KNOW!

UNUSUAL SURVEY REVEALS WHAT RADIO MEN THINK OF RADIO BOOKS

Men! Here's your chance to get started on the right track in your study of Radio—without guesswork and without investing a lot of money!

We contacted a mixed group of 817 radio men composed of Radio instructors, Servicemen, Radio men in the U. S. Military and Naval Forces, in radio manufacturing plants, etc.—asked them to tell us without prejudice or favor just what they think of the

various books and courses offered to beginners for the study of Radio fundamentals. **WE'VE MADE A DISCOVERY!** Nine out of ten of these men—728 to be exact—wrote back that Ghirardi's **RADIO PHYSICS COURSE** is their choice—the most understandable, thorough, and inexpensive Radio book there is—far better than any other book or course they have ever seen!

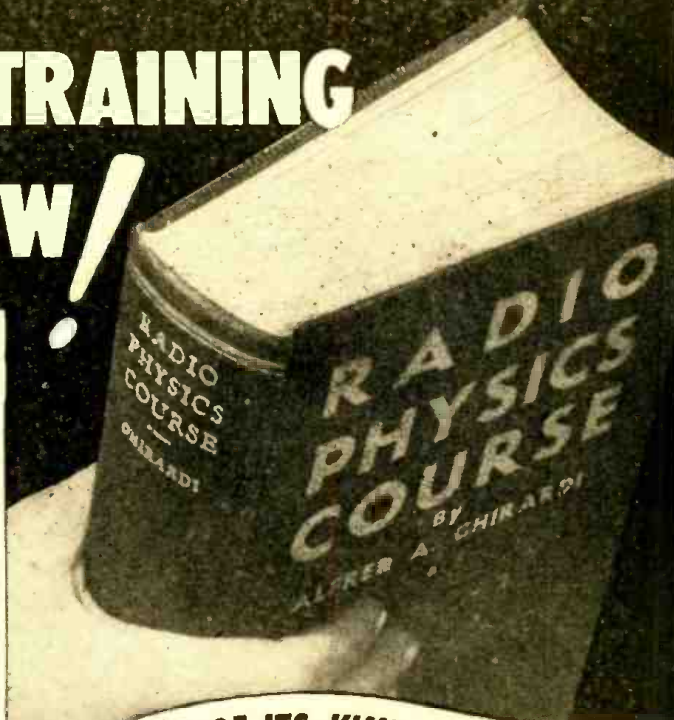

Your Money Back

THE ONLY BOOK OF ITS KIND... 972 Pages

YOUR MONEY BACK! . . . If Ghirardi's big 972-Page Radio Physics Course doesn't teach you the fundamentals of Radio and Electricity faster, easier, and at less cost than any other Radio book!

Are you one of the thousands of men who'd like to learn Radio but can't seem to make up their minds about just what to do or how to get started for a profitable, interesting career? If so, cheer up, for Ghirardi's famous **RADIO PHYSICS COURSE**—the simplified, down-to-earth book from which thousands just like you have learned Radio—is exactly what you need to teach yourself the easiest way, right from the ground up, at home in spare time—and help you check your own progress every step of the way. It's the easiest, quickest, and most inexpensive method of learning the required Radio essentials. That's why it is used and recommended as the text for U. S. Army Signal Corps training courses in Radio fundamentals.

NO OTHER RADIO COURSE LIKE IT

You've never seen any Radio Book like Ghirardi's **RADIO PHYSICS COURSE**—because there isn't any other like it anywhere, at any price. Starting right at the beginning—over 300 pages devoted to the all-essential Electrical fundamentals alone—Ghirardi teaches you EVERY important branch of this fascinating subject. He takes nothing for granted, but illustrates and explains every last detail step-by-step and so carefully that it is crystal clear before you go on to the next. That's the big difference between **RADIO PHYSICS COURSE** and other Radio Courses which take too much for granted. That's why both civilian and military Radio Instructors everywhere report that their students learn Radio far more quickly and easily from this than from

any other Radio text—it's practically a self-teacher. That's why Ghirardi's famous **RADIO PHYSICS COURSE** is used by more U. S. Army Signal Corps, Navy, civilian school and college radio training courses, and for more home study uses than any other basic Radio book published!

SCOPE OF 36 COURSES IN ONE BIG BOOK

Because Ghirardi's **RADIO PHYSICS COURSE** is so comprehensive, and so thorough in its explanations, it is a large volume—larger by far than any other book of its type. Actually, it gives you the scope of 36 different courses in one—packed into nearly 1,000 pages, made easily understandable by more than 500 specially prepared illustrations, and containing 856 self-testing review questions.

5 DAYS TO SEE FOR YOURSELF—AT OUR RISK

Get started at once by mailing the coupon below—now! Our 5-day **MONEY-BACK** Trial Offer enables you to examine this great book without assuming any risk whatever. Prepare now for a fascinating Radio Future—in the Signal Corps, in the Navy, in Aviation, Broadcasting, Electronics, Manufacturing or any of the many other branches! Send the coupon below—**AT ONCE!**

← JUST OUT!

The NEW Ghirardi Book that Helps Servicemen Repair More Radios Easier—and Twice as Fast.

Just the book for busy radio repairmen—the big new **WARTIME EDITION** (3rd Edition) of the famous **RADIO TROUBLESHOOTER'S HANDBOOK**. Now fully revised. Contains 9 additional sections. Covers 75 important subjects. Has 744 big manual-size pages. Helps you cut corners—save trouble-shooting time—train new technicians—repair cheap sets profitably—handle tough jobs in half the usual time—and lots more. Pays for itself the first time you use it! Much larger, more complete—yet sold at the old price of **ONLY \$5** postpaid (\$5.50 foreign).

← MODERN RADIO SERVICING

Ghirardi's popular 1,300-page, one-volume, home-study course on **Troubleshooting and Repairing** radio equipment by the most advanced methods. Covers every phase of the work—explains everything to the last "T" 706 illustrations. Price \$5 (\$5.50 foreign).

SEE MONEY-SAVING OFFER IN COUPON!

THE 3 GREATEST VALUES IN MODERN RADIO TRAINING!

Sold at 1/10th the price you might expect to pay for such complete instruction.

RADIO AND TECHNICAL PUBLISHING COMPANY, Dept. RC-63.
45 Astor Place, New York, N. Y.

Enclosed find payment for books checked below. I understand that, if I am not fully satisfied, I may return them at the end of 5 days and receive my money back.

- Ghirardi's **RADIO PHYSICS COURSE** \$5.00. (\$5.50 foreign)
- Revised **RADIO TROUBLESHOOTER'S HANDBOOK** \$5.00. (\$5.50 foreign)
- MODERN RADIO SERVICING** \$5.00. (\$5.50 foreign)
- MONEY-SAVING OFFER—THE HANDBOOK and MODERN RADIO SERVICING** at special price of only \$9.50 for the two. (\$10.50 foreign)
- Rush free literature on all of above.

Name _____
Address _____
City _____ State _____

MONEY-BACK GUARANTEE!
YOU BE THE JUDGE



ALFRED A. GHIRARDI
World-famous Radio Authority



MAIL NOW ▶

WHAT YOU SHOULD KNOW ABOUT ELECTRONICS

By W. C. WHITE*

ELECTRONICS is defined as "the science which deals with the behavior of electrons." Like many definitions, this one is not very helpful and one must go a step further. Recently I saw a definition which I rather liked and which read "electricity freed from the bondage of wires." That, I think, is better because it is descriptive and intriguing.

The electron is the basic unit of electricity. Just as a drop of water can be considered a sort of basic unit in measuring amounts of water, so the electron is the unit by which we could measure the quantity of electricity. I say "could" because it is not a convenient measure. Again using the drop of water analogy, if we are talking about small amounts of liquids, such as a teaspoonful, it is logical to express the amount by the number of drops. However, when

their interesting and useful properties could not be studied and used.

(Right here, let us bring up the point that the words "electron tube" and "vacuum tube" are used to describe the same device, it being a matter of personal preference which term is used.)

What goes on inside a high-vacuum electron tube depends on two basic components. The first is some source of free electrons and the second includes elements so that the motion of the electrons can be definitely guided. Fig. 1.

The first we can liken to heating water to the boiling point to liberate steam. Heating a metal rod hot liberates electrons from the surface in somewhat the same way.

Now, if that red-hot piece of metal is inside of a highly evacuated bulb, then this cloud of electrons coming out from the surface is very mobile.

Then comes the second step. You have all noticed that, when a comb becomes charged electrically, it will attract dust and bits of paper. In a similar way, the liberated cloud of electrons may be caused to move toward a positively charged terminal placed inside the bulb. Therefore, electrons pass from the hot plate, which is called a cathode, to the positively-charged cold plate, which is called an anode, and the resulting continuous transfer of electrons constitutes a flow of electric current.

If this were all there was to the matter, one might well ask, why all this complication simply to provide a flow of electric current when an ordinary piece of copper wire might accomplish the same purpose? The answer is that this electronic method of conducting electric current offers possibilities of controlling the current in ways that are totally impossible in an ordinary conductor like a piece of wire. This possibility arises from the fact that these electrons may be started, stopped, and deflected very easily. This is done by putting additional electrodes in the tube and operating them at a certain combination of voltages which determines how many of these electrons travel across the space and at what speed and how often they are started and stopped.

Here again, it is well to remember those two separate steps in this process of electrons moving through a vacuum. The first is getting the electrons out of the metal and the second is getting them across the space to the other electrode. It is only during this second step, their trip across the space, that they are subject to control by additional electrodes.

Because such a huge number of electrons are required to carry an appreciable amount of current and because they move so rapidly, the flow of current through the tube can be subject to variations of an extraordinary degree as regards speed and nature of the variation.

This means that, if a wire carrying a small current is cut and this elementary vacuum tube is inserted in this gap in the circuit, you have great opportunities for unusual control of current in that circuit. When I say, cut the wire and insert the

tube, I mean that one of the free ends of the cut wire, the negative one, is connected to the hot-cathode terminal of the tube and the other, the positive, is connected to the cold anode plate.

That in its simplest form is an electron tube in an electrical circuit. During the split second when the electric current in this circuit is in the form of a stream of free electrons leaping across the gap through the vacuum of the tube, you can control this current with great speed and accuracy. The control element in the tube is usually like a screen or grid which is placed directly across the stream of electrons. Fig. 2.

If to this grid or control electrode a proper voltage is applied, the current through the tube, and thus the current in the circuit, may be varied. The kind of tube used depends on the magnitude of the currents and voltages involved and how fast the control has to be, and it can easily be up to a billion times a second.

It is natural to ask why, year after year, we continue to use electron tubes both in our radio receivers and radio transmitters. Is it not possible to substitute for them other devices that will do the job as well or better? The answer is "no" and will probably continue to be "no" in radio for a very long time to come because electron tubes can do certain things that just cannot be done in any other way.

There are several reasons why electron tubes are the heart of radio equipment. The first of these results from their almost complete independence of electrical frequency. As you well know, many electrical devices are suitable only for use on direct current or only on the one frequency of 50-cycle alternating current. However, as we have seen, an electron tube can function at millions of cycles a second just as well as at 60 cycles. It can do this because the myriads of electrons in the evacuated space inside the bulb can move at such enormous speeds that the frequency range mentioned above is

(Continued on page 568)

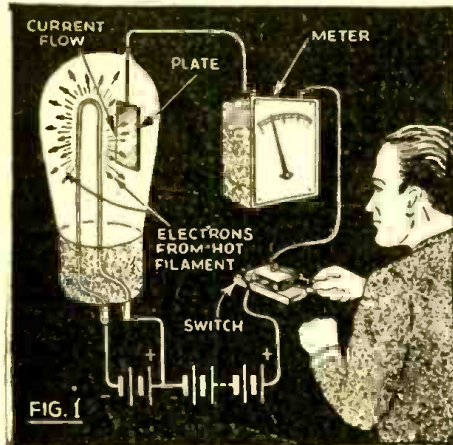

speaking of large amounts of water, such as go over Niagara Falls per hour, it would be absurd to express them by the number of drops.

The same thing is true of electrons. Even the number of electrons that make up the small current used in the filament of a household incandescent lamp is so huge and, therefore, runs into so many significant figures that we don't talk about the electric currents we use in such terms.

However, the electron is a very real thing and its mass and charge were accurately measured by scientists many years ago.

In addition to the extremely small charge it carries, the other unusual property of the electron is the enormous speed at which it can travel under proper conditions; a speed that can approach that of light. Here again, we do not express this speed in such terms as miles per hour because the number of zeros after the figure would make it too bulky to use. Instead we speak of the voltage used to accelerate the electrons.

Now, let's go back to the idea of free electrons, because that is important. Until scientists created the so-called vacuum tube for these electrons to perform in, they were not free to be moved about as desired and

*Engineer in Charge, General Electric Electronics Laboratory, Schenectady, N. Y.

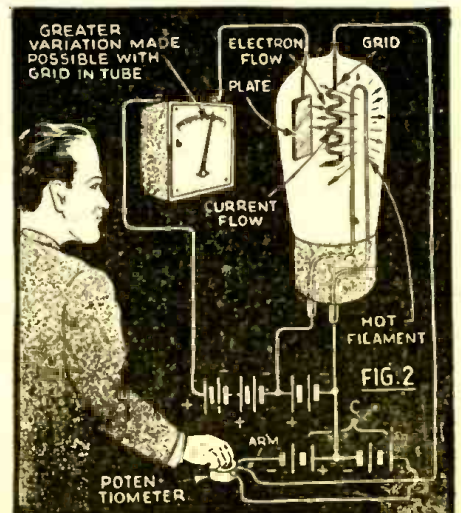

PHONES AND SPEAKERS

HOW DO THEY WORK?

THE beginner has already learned how the microphone changes sound to electric impulses for transmission by radio. ("Microphones Explained," in January, 1943.) Other articles have dealt with the reception and amplification of the radio waves modulated by these currents from the microphone. Now it is time we learned how these electric impulses are changed back again into impulses of sound, to reproduce those spoken at the point of transmission.

The telephone receiver is the instrument which makes this change. Known variously as telephone, headphone, "earphone" or simply as "the receiver," it was used in its original form, as shown in Fig. 1, from the time of its invention by Alexander Graham Bell till the early days of broadcasting.

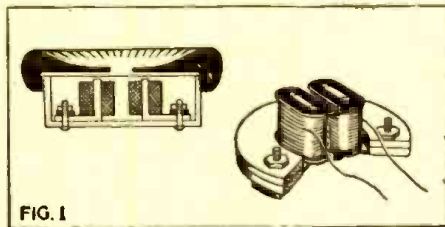

As will be seen from the figure, a telephone receiver consists of a thin flat sheet of iron suspended over the poles of a magnet. The sheet of metal is cut into a disc to fit the familiar "watch-case" shell. The horseshoe magnet is so constructed that its poles turn up at right angles and lie close under the center of the sheet metal diaphragm. This diaphragm is drawn down slightly by the attraction of the magnet. The little spools on the pole-pieces are coils of very fine wire, through which flows the current from the plate of the last amplifier tube. In one-tube sets, it is the current from the detector tube that operates the phones, and in crystal sets, the rectified signal current from the crystal circuit.

The current through the phones is varied by the signal received from the aerial. If a thousand-cycle note is being received, for example, the strength of the current in the phones strengthens and weakens one thousand times a second. Each time the current strengthens, the diaphragm is pulled down a little from normal position, and each time it weakens, it springs back a little farther than its usual resting position. Thus the diaphragm moves up and down (vibrates) one thousand times a second, and we hear a thousand-cycle note.

This type of telephone receiver was quite satisfactory on the regular telephone circuits, and it was not till broadcasting developed that the need for a better receiver spurred inventors to search for other types of sound reproducers.

THE AMPLIFIER ARRIVES

The line telephone—used solely for person-to-person communication—did not produce loud sounds. The signals had only to be loud enough to be heard by the person listening. Only the coming of the electron-tube amplifier made it possible to carry the

low-intensity signals far enough along the lines to make real long-distance telephony possible.

The vacuum-tube made it easy to increase the sound to any level desired. Telephone engineers, however, arranged it so that signals still reached the listener's ear with about the same intensity as before, and used the extra power to send conversations across the continent. Not so the broadcast listener. He put his telephones in a bowl or soup-plate, turned up the volume control, and called others to listen to the program. With the help of the soup-plate technique, persons around, (usually within a radius of two feet) could listen to the program. A device made from an old auto horn was produced and sold. The phones were clamped to the base of this, and the loudspeaker was born!

EARLY LOUDSPEAKERS

The horn attached to the phones greatly increased their usefulness, making it possible for a number of people to listen to one unit, without the inconvenience of wearing telephone receivers. It also exposed a number of weaknesses of the telephone unit and created a demand for improvements. Before we go into the story of these improvements we will stop to consider another question, "Why did putting a horn on the telephones make it possible to hear sound farther?"

As you know, the telephone diaphragm produces sound by vibrating. When it vibrates, it pushes air ahead of it on each forward motion and attempts to draw it back on each backward motion. It is this vibration of the air caused by the diaphragm

that reaches our ear drums. The air acts as a coupling unit between the diaphragm of the telephone and our ears.

Now note the effect when a receiver is laid down on a table and left to vibrate. Fig. 2 (a). As before, it sets up vibrations in the air immediately ahead of it. Some of the air is pushed straight forward and travels out into the room. Much flows to the side and even spills around behind the unit. This is drawn back again as the diaphragm moves backward. Thus the receiver sets up a mere local disturbance in the air near it without having much effect on the air in the room as a whole. The waves moving in some directions cancel those in others, with the result that very little sound gets

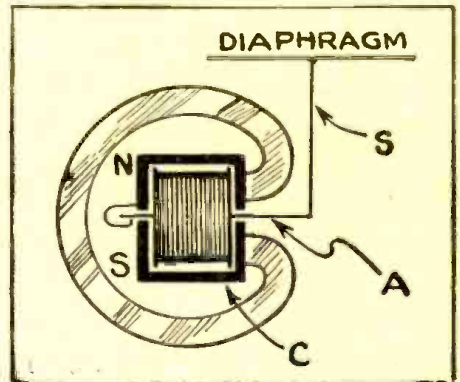

Fig. 3. The balanced armature unit. Small hair-pin is a spring which keeps A centered.

far from the receivers. Too small a surface—a point almost—is trying to set too much air in motion. The layers of air simply slide by each other and little is accomplished.

The effect of placing a horn over the receiver is shown in Fig. 2 (b). All the energy of the diaphragm is now expended in pushing forward a small column of air directly ahead of it. This column pushes against one a little wider, but not so wide that there is any tendency for the layers of air to slide past each other. By controlling the widening out of the horn, we can assure that each section of the column of air is effectively coupled to that directly ahead of it, right down to the mouth or bell. If this mouth area is great enough, it will couple efficiently with the air ahead of it, and the sound will be heard with fair volume all over the room.

A horn is therefore a device to couple the telephone diaphragm to the air in the room. This may be compared to pushing a thin layer of snow off a sidewalk. If a stick is used for this, it will simply push through the snow directly ahead of it, forcing it to both sides, and move practically no snow. But if a short piece of board is nailed across the end of the stick, we have an efficient means of coupling to the snow, and large quantities can be moved in a single thrust.

The horn, by the way, has never been excelled as a sound-coupling unit, and though displaced by the more convenient cone in home receivers, is still used where
(Continued on page 568)

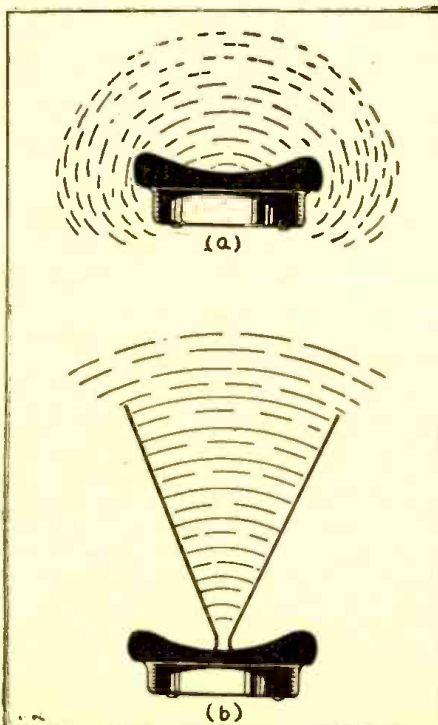

Fig. 2 (a) Sound waves from unit lying on table; and (b) with horn placed over unit.

ALLIED

ARSENAL of SUPPLY for
EVERYTHING in RADIO
and ELECTRONICS.



GET all your Radio and Electronic needs quickly from this ONE dependable central source of supply...over 10,000 items for the Armed Forces, for Radio Training, for Research Laboratories, for War Industries, and for Service Replacement. Our large complete stocks speed delivery. Our experienced staff is ready to help you. Send for your new Allied Catalog today...it's FREE!

USE THE NEW ALLIED CATALOG! Most Complete Up-to-date Buying Guide **Free**

SEND FOR THESE NEW BOOKS

- Dictionary of Radio Terms, No. 37-751 10c
 - Radio Data Handbook, No. 37-754 25c
 - Radio Circuit Handbook, No. 37-753 10c
 - Radio Builders Handbook, No. 37-750 10c
 - Radio Formulas & Data Book, No. 37-752 10c
 - Simplified Radio Servicing, No. 37-755 10c
- Write for Quantity Prices

ALLIED RADIO CORP., Dept. 2-F-3
833 W. Jackson Blvd., Chicago, Ill.
Please send following books (.....c enclosed)
 FREE 37-750 37-752 37-754
1943 Catalog 37-751 37-753 37-755

Name.....
Address.....
City..... State.....

ALLIED RADIO

A SIMPLE TEST PANEL

By ALBERT E. WILDER

HERE is a simple but handy test panel for any radio shop. More meters are to be added, but I find these two are those most commonly used.

The panel has a sloping front. It measures twelve by nine inches, and has a slope of six inches in the back to one and a half inches in the front. The panel is made of one-quarter inch boxwood finished in brown stain.

Three switches are used on this panel. Switch No. 1, a double-pole toggle switch, is the main switch. A red pilot light shows when the panel is on. Switch No. 3 is a single-pole double-throw knife-switch. When the arm is thrown to X, three circuits are "hot."

Circuit "C" (the letters stand for the binding posts) has an outlet of six volts which may be used to run small motors, lights, bells, and other such electrical appliances.

Circuit "D" is used for testing condensers, resistors, coils, etc. When a condenser or resistor is placed across this circuit, the 2.5 V. bulb will light if the part is good. Filaments of most tubes may be tested this way also.

The third circuit is at "A." This is a device I made up from a piece of tin and an ordinary wood screw. A V-shaped bracket made from the tin is mounted on the panel and the wood screw set in front of it. This is so a bulb (any size from 2.5 to 12 volt) may be easily slid into the bracket to test it.

When the arm of the knife-switch is thrown to "Y," Circuit "E" is hot. This

puts a small 6 to 12 volt buzzer into operation. This circuit may be used the same as Circuit "D."

One main purpose of this circuit is to test volume controls. When the control is turned on full, the buzzer will ring loudly, and as the control is turned down, the buzzer will grow faint. I found that this test does not always work on a light, so I used the buzzer.

Circuit "B" is the same as Circuit "A," only 110-volt light bulbs are tested. Plug fuses may also be tested here.

Switch 2 is inserted so no open circuit can exist on the board.

A 110-volt plug receptacle is also mounted on the board. Various appliances may be run from this receptacle, such as a soldering iron, or a radio, etc.

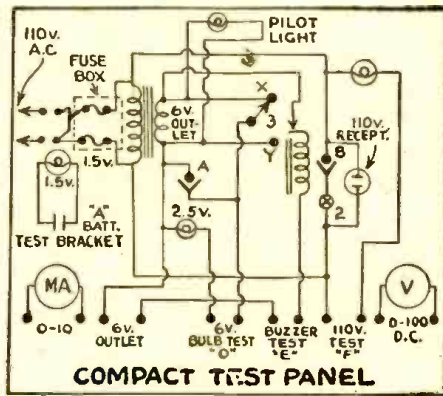

COMPACT TEST PANEL

VOLUME EXPANDER

By HARRY NEWTON

THIS expander really delivers the goods. Former expanders had several disadvantages including slow action, considerable distortion, inability to handle large changes in volume and difficulty of adjustment. The dynamic peak of a symphony orchestra is about 70-DB, and most expanders will not handle this without a lot of

distortion. All of the recording companies use compressors when making records, and when these records are played back on the expander to be described, the result is a revelation to the listener.

The expander unit is made up as follows. A variable-mu 6SK7 is used as a Class A

(Continued on page 569)

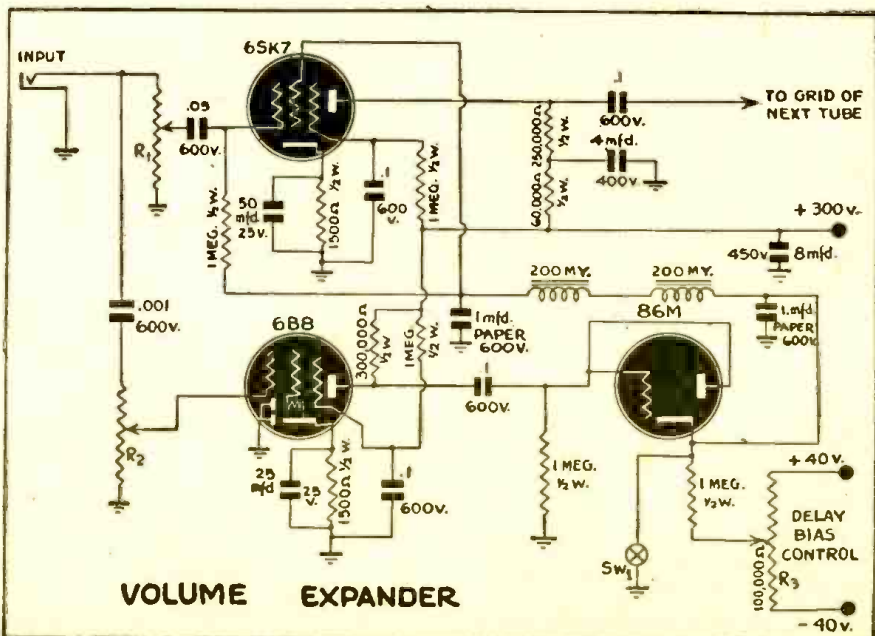

VOLUME EXPANDER

QUESTION BOX

QUERIES

All queries should be accompanied by a fee of 25c to cover research involved. If a schematic or diagram is wanted please send 50c, to cover circuits up to 5 tubes; for 5 to 8 tube circuits, 75c; over 8 tubes, \$1.00.
 Be sure to send the fullest possible details when asking questions. Give names and MODEL NUMBERS when referring to receivers. Include schematics of your apparatus whenever you have such. Serial numbers of radios are useless as a means of identification.
 No picture diagrams can be supplied.
 Back issues 1942, 25c each; 1941, 30c each; 1940, 35c each.
 Any issue, prior to 1940, if in stock, 50c per copy.

SHORT-WAVE CONVERTER

? Will you kindly supply me with a diagram for a short-wave converter using miniature type tubes 1R5, 1T4, 1S5 and 35Z5. Set to have its own power pack and to operate on A.C.-D.C.—W. D., Brooklyn, N. Y.

A. The diagram you ask for is given. As your choice of tubes is such that it is not clear whether you wish it to work as a radio-frequency converter or to work into the audio end of a receiver, both connections are shown. The switching system permits using the converter, with either a high- or low-impedance antenna coil, L5 being wound with a small number of turns to couple to low-impedance antenna inputs. Try 20 to 30 turns.

The set is shown with a 25Z5, but can be used with a 35Z5 by making the con-

nection shown in the dotted lines and substituting a 500-ohm line-dropping resistor for the 270-ohm resistor shown in the figure.

Any standard set of short-wave superheterodyne coils may be used, or the following scale may be used:

Number of turns				Spacing
L ₂	L ₁	L ₃	L ₄	L ₁ and L ₃
5	4	4	4	6 per in.
13	7	10	6	10 per in.
27	9	22	8	20 per in.
66	14	56	10	Close

All turns wound on 1½-inch coil forms, with any wire which can be spaced as directed, or with No. 30 throughout if desired. All ticklers close-wound. These four coils should cover the range from about 13 to 200 meters.

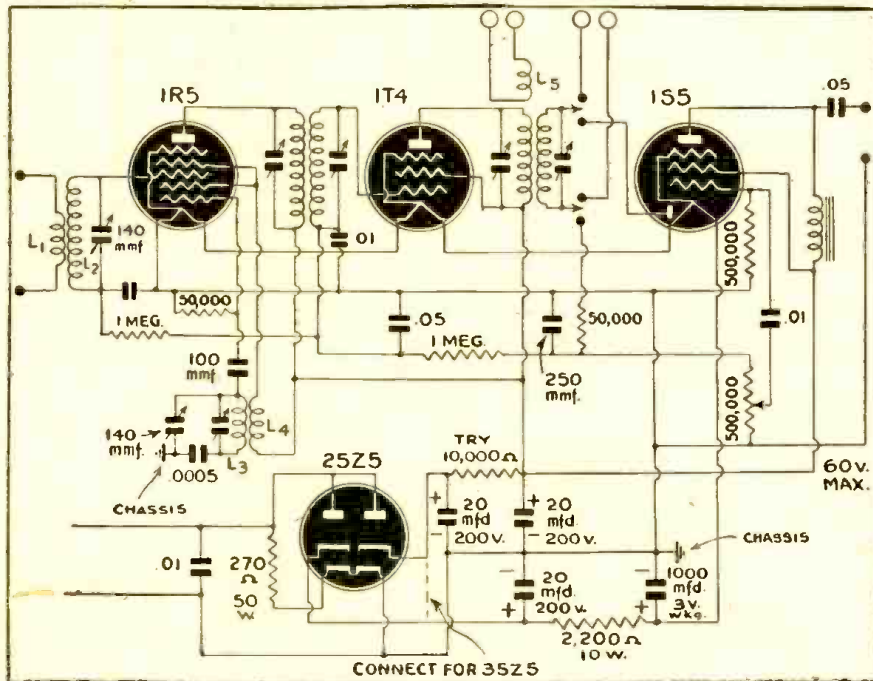

SOME SERVICING QUESTIONS

? Can you help me with the following:

1. What causes a 25Z5 tube to flash inside?
2. What causes 6F6 and 5Z4 tubes also power transformer to get hot after a short time?
3. Set fades when detector, 6A7 or chassis are touched by hand.
4. 25Z5 tube blows in portable, also resistor gets hot.
5. Set oscillates when grid caps are touched.

6. Grid cap of 75 causes set to squeal when touched.
7. Speaker produces ping sound when volume control is turned on past middle, and in other cases it makes set oscillate.
8. What causes power transformer to get hot and slightly melt wax after about half hour?
9. What causes R.F. sets to lose selectivity on local stations and oscillate on distant ones?
10. Small A.C.-D.C. sets sound tinny also distorted.—F. C., Ardmore, Mich.

SIGNAL TRACER

? I have built the Olson Signal Chaser from the July, 1940, Radio-Craft but am stuck at the output circuit. Can you give me a diagram for that also?—B. C., Bronx, N. Y.

A. A completed diagram of the Signal Tracer Test Unit, with a type 42 output tube and a 6E5 electron-ray indicator, was published in the Mailbag section of Radio-Craft for August, 1941.

QUESTION BOX

for Permanent Resistance Today and Tomorrow...

OHMITE Resistors

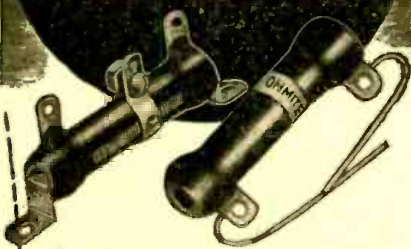

Consistent performance day-after-day under a wide range of operating conditions has proved the dependability of Ohmite Resistors. This rugged quality has enabled Ohmite Brown Devils and Dividohms to keep existing installations going longer. It has also made them especially well fit for today's wartime applications... and tomorrow's peacetime needs.

Handy Ohm's Law Calculator

Figures ohms, watts, volts, amperes—quickly, accurately. Solves any Ohm's Law problem with one setting of the slide. Send only 10c in coin for handling and mailing. (Also available in quantities.)

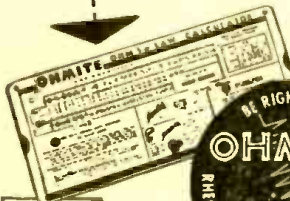

10c



OHMITE MANUFACTURING CO.
4866 FLOURNOY ST., CHICAGO, U.S.A.

SMALL SET WITH ELECTRON-RAY TUBE

Q I would like to have a diagram of a small set to use a 6D6, 6C6, 25L6, 25Z6 and a 6E5, also 2 L-55-B ballast tubes.—J. U., Chicago, Ill.

A. The diagram is shown herewith. This

is more or less an experimental hookup, as electron-ray indicators are not generally used with small sets of this type. Only one L-55-B ballast tube is needed here, and may be replaced with a 160-ohm line cord.

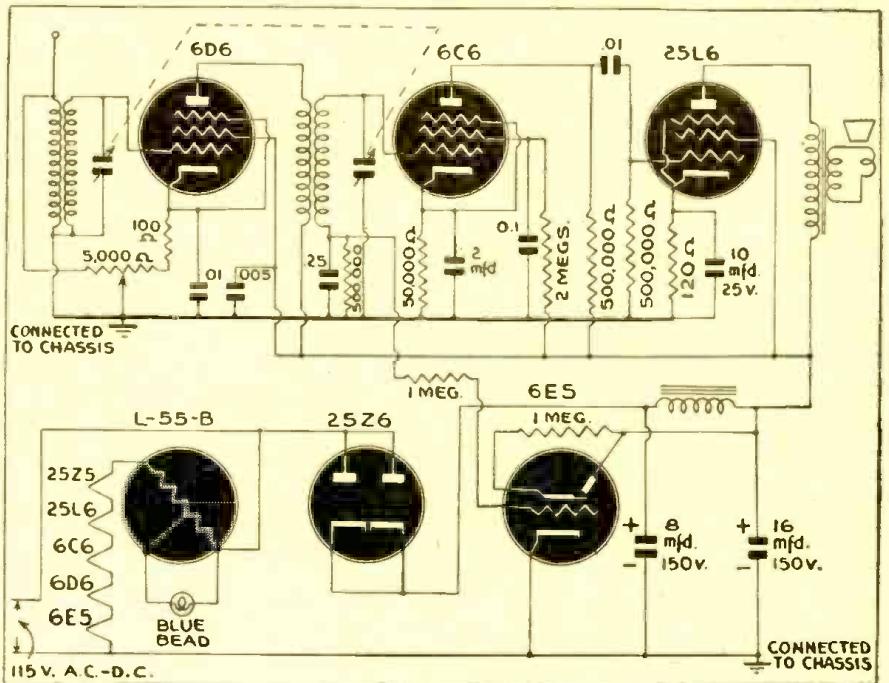

THREE-TUBE PHONO AMPLIFIER

Q Will you please print a hook-up of a small phonograph amplifier, to use as few tubes as possible? I would like to use an 80 rectifier.—W. R. B., Wickliffe, O.

A. Herewith the diagram requested. If you substitute an A.C.-D.C. power supply, this will make a very small phonograph amplifier.

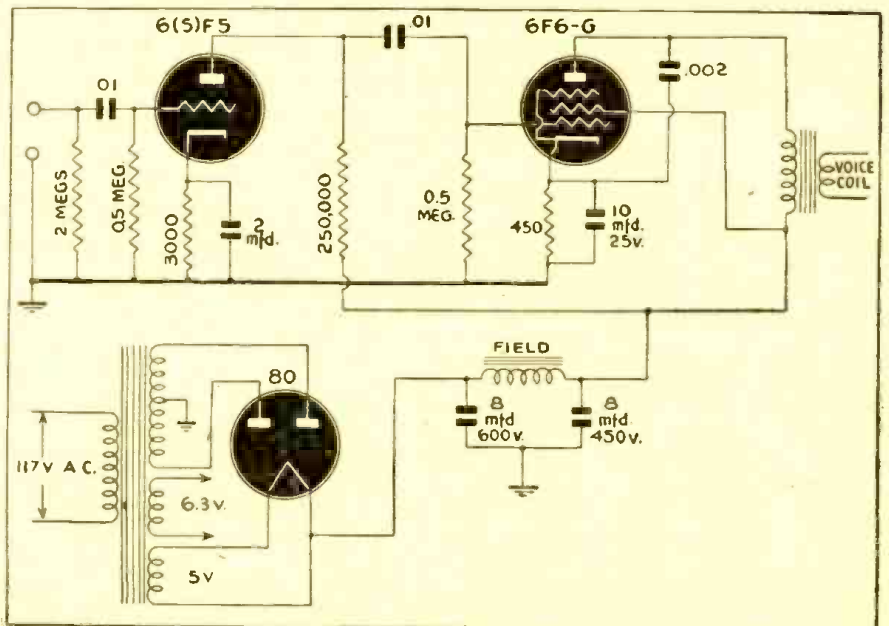

STANDARDS FOR VICTORY PARTS

The American Standards Association recently released the first of a series of standards for the manufacture of "war model" replacement parts, designed to keep 90% of the nation's home type receivers in

operating condition during the war period. Production of the parts will soon be under way, and it is promised that when they are available for purchase, price ceilings will prevail.

NEW WORLDS TO CONQUER!

**FOR SERVICE MEN...
THE "ELECTRONICIANS"
OF THE FUTURE!**



PRECISION

Under the guidance of this skilled operator a bending machine in the Stem Department is shown doing its war job of helping to provide this year the largest number of the finest electronic tubes National Union has ever built.

Sure, winning the War is our big job right now. To that end we here at National Union are exerting our every thought and energy—both on our production lines and in our research laboratories. But after the war—what then? For you as a service man the post-war outlook is especially promising. New applications of electronics in the home will add new and profitable service activities to your already established business. From radio technician you will expand to become your community's "electronician." And National Union will have ready for you the tubes, the test equipment and a plan of action.

Transmitting Tubes • Cathode Ray Tubes • Receiving Tubes •
Special Purpose Tubes • Condensers • Volume Controls • Photo
Electric Cells • Exciter Lamps • Panel Lamps • Flashlight Bulbs

NATIONAL UNION RADIO CORPORATION
NEWARK, NEW JERSEY LANSDALE, PENNSYLVANIA

NATIONAL UNION ELECTRONIC TUBES

LAST YEAR'S BONDS GOT US STARTED

THIS YEAR'S BONDS

ARE TO WIN!

★ Last year saw nearly 30,000,000 workers voluntarily buying War Bonds through some 175,000 Pay-Roll Savings Plans. And buying these War Bonds at an average rate of practically 10% of their gross pay!

This year we've got to top *all* these figures—and top them handsomely! For the swiftly accelerated purchase of War Bonds is one of the greatest services we can render to our country . . . and to our own sons . . . and our neighbors' sons. Through the mounting purchase of War Bonds we forge a more potent weapon of victory, and build stronger bulwarks for the preservation of the American way of life.

"But there's a Pay-Roll Savings

Plan already running in my plant."

Sure, there is—but how long is it since you've done anything about it? These plans won't run without winding, any more than your watch! Check up on it today. If it doesn't show substantially more than 10% of your plant's pay-roll going into War Bonds, it needs winding!

And you're the man to wind it! Organize a vigorous drive. In just 6 days, a large airplane manufacturer increased his plant's showing from 35% of employees and 2½% of pay-roll, to 98% of employees and 12% of pay-roll. A large West Coast shipyard keeps participation jacked up to 14% of pay-roll! You can do as well, or better.

By so doing, you help your ma-

tion, you help your workers, and you also help yourself. In plant after plant, the successful working out of a Pay-Roll Savings Plan has given labor and management a common interest and a common goal. Company spirit soars. Minor misunderstandings and disputes head downward, and production swings up.

War Bonds will help us win the war, and help close the inflationary gap. And they won't stop working when victory comes! On the contrary—they will furnish a reservoir of purchasing power to help American business re-establish itself in the markets of peace. *Remember, the bond charts of today are the sales curves of tomorrow!*

You've done your bit  Now do your best!

THIS SPACE IS A CONTRIBUTION TO AMERICA'S ALL-OUT WAR EFFORT BY
RADIO-CRAFT

RADIO HOOK-UPS

HARTLEY AUDIO OSCILLATOR

The circuit shown below was designed by me to use up some spare and junk parts. A push-pull input transformer with a burned-out primary, or secondary, will do for T2.

Any resistor, 500 to 2000 ohms, 5 to 10 watts, can be used for R2, but a choke coil would probably be better.

The filament circuit can be either A.C.-D.C., as shown in (B), or straight A.C., as shown in (A). In the A.C. circuit, a

6-volt bell-ringing transformer can be used.

Tubes for the A.C. circuit can be a 6-volt triode, or pentode triode-connected. Also the 1V, 6X5, 37, 76, 6C5, or 6J5, can be used.

For the A.C.-D.C. circuit, tubes such as the 12J5, 12SJ5 may be employed, with a 25J5, 35Z5, 45Z5 or a 25Z6, as a rectifier.

The variable resistor acts as a tone-control.

LAWRENCE LEIPUNER,
Miami, Florida

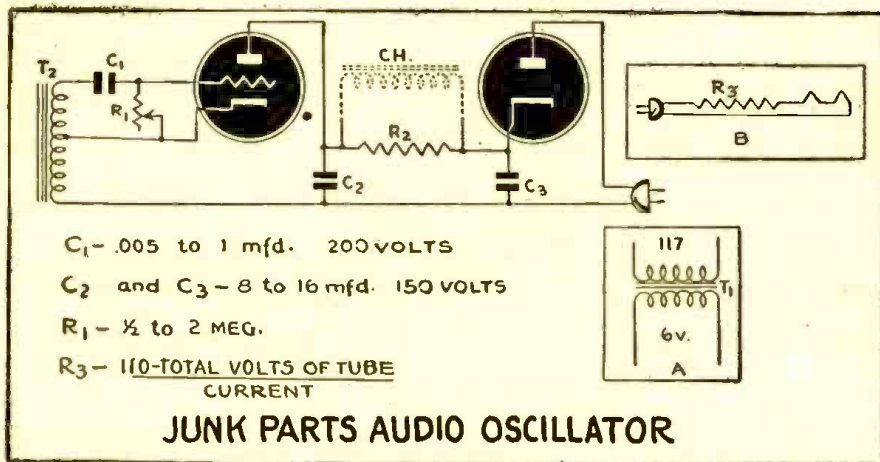

POWER-LEVEL INDICATOR FOR RECORDING

Mr. Harry Morton inquired in a recent "Mailbag" about power-level indicators for use in recording. Attached you will find a circuit drawing of my indicator.

Although it uses only a 6E5, and is not of the DB needle-type, it has its advantages, and I find myself using it more than the DB-meter, with very good results.

Three leads are brought out from the amplifier. The two leads from each plate are connected to R1 through condensers C1 and C2. The B plus lead is brought to the target of the 6E5. If the voltage is more than 250 volts, the resistor in the dotted box is inserted to bring it down to that value.

The output transformer is shown only to indicate that the three leads must come from its plate side. The circuit will not work from the output side.

In recording, a certain power level must be reached for the stylus to cut a good pattern on the record. With the 6E5 as indicator the "eye" will not start to close until

this level is reached. This is due to resistor R4 in the cathode lead to ground. The value of this resistor may be different with a magnetic type cutting head. A crystal cutter, with a sapphire needle, was used with this indicator. The eye will "wink" every time signal is passing through the amplifier. This type of indication is satisfactory to those in the recording line object to the needle type of indicator because of the extreme swinging of the needle. To such this is a more usable device.

When circuit is wired and ready for use, turn on the amplifier and turn the volume control to "0." Adjust R4 till about a 90-degree shaded area appears on the 6E5. There is no further need for adjustment.

When ready to cut a record, switch off the speaker and use headphones for monitoring. Bring volume up till the eye winks on all signals. The eye closes more on the bass notes or low frequencies than it does on the higher frequencies.

A test recording will prove the value of the 6E5 as a power-level indicator.

The values of resistors and condensers are as follows:

- R1 2 megohm potentiometer
- R2, R3 1-megohm
- R4 1,000 ohms, approximately (See text)
- C1, C2 .05 mfd. paper
- C3 .02 mfd. paper
- C4 10 mfd. electrolytic

Contributor failed to give his name.

No NAME,
Brooklyn, N. Y.

TWO RECEIVERS IN ONE TUBE

This circuit was designed to facilitate QSO's with two friends who operated on 20 and on 160 meters in pre-Pearl Harbor days. By using two switches instead of the S.P.D.T. switch shown in the diagram, it may be used as a stand-by receiver to cover two frequencies at the same time.

T1 and T2 are separate coils on plug-in coil forms, mounted far enough away from each other that they do not interact. Two short aerials were available and no ground was used. The tube originally used was a 6A6, but a 6C8-G lends itself more efficiently to the circuit, because of the separate cathodes.

For simultaneous QSO, a 20- and a 160-meter coil was plugged in, and each one tuned to the frequency of the station sending on its wavelength; then a flip of the S.P.D.T. switch would bring in either one of the stations instantly.

It seems to me (though I have never tried it) that two coils for the same band could be plugged in and both tuned to the same frequency, much like the "Dual Diversity" receivers. As you know, these used two complete R.F. ends, feeding into a single audio output. If two antennas from opposite directions are used, fading may be largely overcome. It has been demonstrated that "Dual Diversity" receivers may bring in a signal R8-9, as compared to only about R6 or 7 in other receivers.

EARL BALLARD,
Cincinnati, Ohio

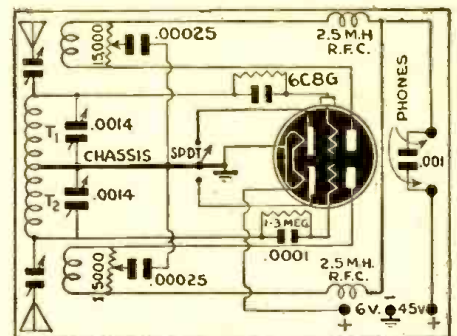

TEST AMPLIFIER

The circuit shown here, of the 117L7GT, is a compact little set-up for making a lot of little tests on the experimenting bench.

To the input you can hook-up any kind of signal you want to amplify—output from a 1-tube receiver, or a phone pick-up, or from a signal generator, etc.

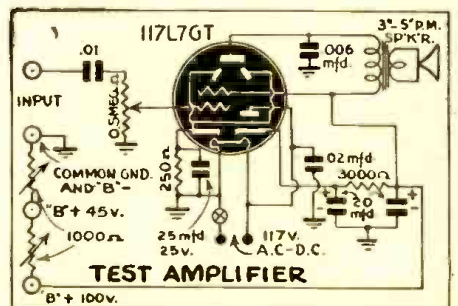

Also, inasmuch as the rectifier portion of the 117L7GT furnishes B-supply, you can get any voltage from 90 volts D.C. down to 22 $\frac{1}{2}$, by using two variable resistors of about 1000-ohm capacity each; or a fixed power resistor with several taps that can be slid along can also be used.

FRED U. DILLION
Hollywood, Calif.

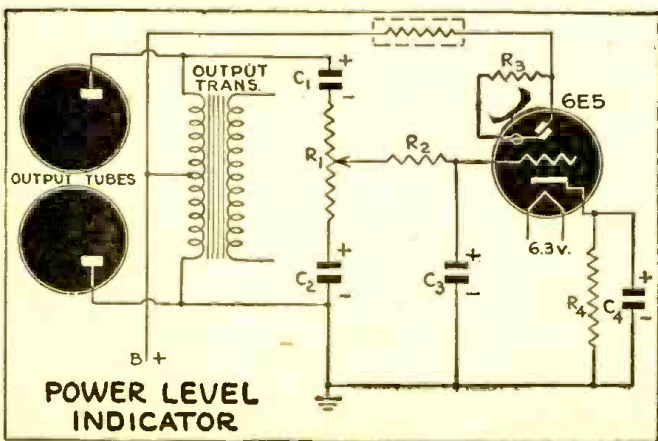



GRAB YOURSELF A COPY OF THIS BRAND NEW MANUAL BOYS! ITS JAM PACKED WITH DATA, CIRCUITS AND ALL THE SET INFO YOU NEED UP TO DATE OF GOVERNMENT SHUT DOWN APRIL '42.

**Read These Facts!
LOOK AT A COPY NOW**

See for yourself — COMPARE!

MORE LISTINGS: This 1942 Radio Circuit Manual has nearly 400 more listings than the last edition of a similar manual. Covers receivers manufactured up to time of Government shut down order in April 1942. The set you're looking for here when you need it!

MORE POPULAR SETS: Listings of many popular set models are far more complete than in other manual recent edition. Check for yourself on such makes as Lafayette, Emerson, Pilot, Philco, RCA, Stewart Warner. This completeness will save you many times the cost of the book by saving your time enabling you to handle work more promptly.

PERFECT DIAGRAMS: There's nothing more annoying or costly than finding an incomplete circuit drawing. An artist carefully checked and retouched every diagram in the Radio Circuit Manual to make sure of PERFECT diagrams. The printing is clear, distinct, complete! You'll enjoy using this manual.

MORE ON PAGE: Ever had to fumble around turning pages because complete information didn't appear on one page? The Radio Circuit manual has big roomy pages which permit more complete data on a single page than any other manual. Another time-saver for you.

HANDY SIZE: The Radio Circuit Manual is thin, not fat, dumpy and bulky. This thin size and large page size makes it much easier to handle, easier to store

in a minimum of shelf space. The book lies open too, without pages flopping over so you have to hunt for your place again.

QUICK REFERENCE INDEX: The index in this manual is complete for both 41 and 42 editions. A big feature is the fact it tells you at a glance if a model is the same as another model number. No hunting back and forth, it's right there. Big readable page numbers and model numbers make for quick finding of what you want.

SPECIAL REFERENCE CHARTS: Special late edition charts on tube and battery interchangeability, pilot lights, ohms law, color codes. The information you often search for is here. Also a special article by F. L. Sprayberry to make your wartime service job easier.

COMPLETE DATA: The big pages feature not only Schematics, but quick reference IF spot, Parts Lists, Dial Stringing diagrams, tuning range and data, tube locations, voltage charts, trimmer locations, push button set-ups, alignment notes and procedures, record changer details.

Published By
RADCRAFT PUBLICATIONS, INC.
25 WEST BROADWAY,
NEW YORK, N. Y.

RADCRAFT PUBLICATIONS, INC., 25 WEST BROADWAY, NEW YORK, N. Y. DEPT. RC 6-43
Gentlemen: Enclosed find my remittance of \$10.00 for which send me, POSTPAID, my copy of the RADIO CIRCUIT MANUAL-1942
Name Address City State
(Send remittance in form of check or money order; register your letter if you send cash)

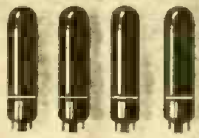

4 STANDARD TYPES
of Amperite Regulators replace over 400 types of AC-DC Ballast Tubes now in use.

Amperites are real REGULATORS . . . have patented Automatic Starting Resistor which prevents initial surge and saves pilot lights . . . Ask Your Jobber.

AMPERITE

THE *Simplest* WAY TO REPLACE **BALLASTS**

WRITE FOR REPLACEMENT CHART
AMPERITE CO. 561 BROADWAY, NEW YORK, N. Y.

TRIPLETT *Combat Line* TESTERS

Pocket Size
MODEL 666H



TRIPLETT VOLT-OHM-MILLIAMMETER

Although some older designs are no longer obtainable, several alternate models are available to you under Government requirements.
TRIPLETT ELECTRICAL INSTRUMENT CO., BLUFFTON, OHIO

TRANSFORMER IN CATHODE CIRCUIT

In audio amplifiers, a low-gain triode with a step-up transformer will often give more gain than the high- μ type resistance-coupled. Accordingly, a high- μ tube and a transformer should be an ideal setup where voltage amplification is desired.

However, due to the high plate load required for high- μ tubes, transformer coupling is not practical.

There is a way to use high- μ tubes with transformers. Connect the primary in the cathode circuit as shown in Fig. 1. The only requirement is that the direct current resistance, not the impedance, must be of such a value as to replace the cathode resistor. Either push-pull or single tube transformers may be used. In case of the latter, ground one side of the secondary or return it to a point where bias is being fed to the tube being excited. This last statement goes for push-pull operation also.

As the plate voltage does not have to be fed through a high resistance, more of it reaches the plate, with an increase in amplification. As the size of the cathode resistor varies with the amount of plate current and plate voltage, proper matching of the transformer on hand can often be accomplished by varying this voltage.

The setup usually produces the good low frequency response, so desirable in P.A. amplifiers.

If a resistor is used in the plate circuit, it should be by-passed.

A.F. AND R.F. AMPLIFIER

It is often desirable to have an amplifier that will pass both R.F. and audio signals. Until the advent of some of the new high gain tubes, this was not practical. But if the circuit shown in Fig. 2 is followed closely, a very efficient wide-range amplifier can be built.

The tube is the 1852, which is directly interchangeable with 6SK7, with the excep-

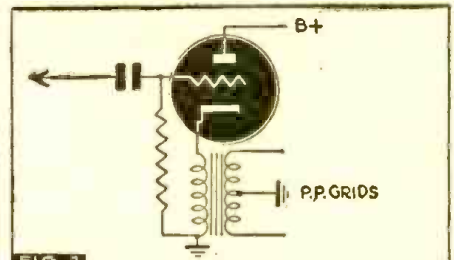

FIG. 1

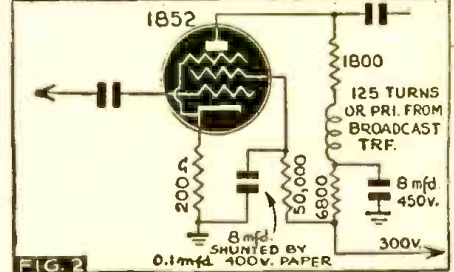

FIG. 2

tion of the gain. The 1852 is the highest gain tube yet offered the serviceman.

The coil in the plate circuit can be wound with about 125 turns of No. 28 wire (or the primary of a broadcast TRF coil will usually suffice). The screen by-pass is composed of an 8-mfd. shunted by a 0.1 paper condenser.

If two or more stages are used, the coupling condensers should be composed of an 0.02 paper shunted by a 0.003 mica condenser.

The amplifier is fairly consistent over the audio band and up through 3,000 k.c.

This circuit should have a wide application in signal tracers, etc.

HAROLD DAVIS,
Jackson, Miss.

SERVICE BENCH POWER SUPPLY

This pack gives a wide range of "B" voltages and filament voltages (1.4; 2.5; 6.3). It is used in the shop to power the V.T.-V.M., the signal tracer, and all experimental receivers.

A transformer from an old T.R.F. set, with two 2.5-volt secondaries was used. It was designed to carry several tubes with heavy filament currents, and gave slightly over 3 volts on each filament winding on "no-load" circuit. By connecting the two windings in series, 6.2 volts was obtained, and by bringing out the center tap it was possible to obtain 2.5 volts (or a little more).

The 1.4-volt filament supply is from a

No. 6 dry cell, and serves to test all small battery sets undergoing service.

The B-supply is conventional. It uses the filter choke from the same big T.R.F. receiver, with an adjustable resistor across the output filter. Adding a second tap and bringing out taps to the terminal board any B-voltage up to 350 is obtainable. Those selected were 100, 250 and 350 maximum.

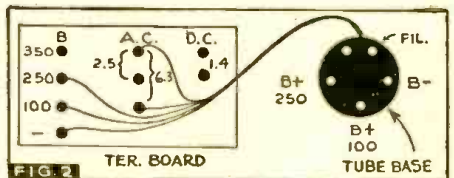

FIG. 2

The terminal board was made up of a piece of black bakelite with figures scratched on and chalked in.

The following parts were used in constructing this power supply. This list is as a suggestion only, as the pack can be built up from parts already in the junk box:

- R1 30,000-ohm, 25-watt (adj.)
- C1, C2 8 mfd, 450-volt
- T1 Transformer, as described
- 80 Tube (and socket)
- B1 No. 6 dry cell
- Sw1 SPST toggle switch

Terminal board, 4x6, bakelite, small metal chassis, etc.

E. H. POGEL,
Fitzroy Harbor, Ontario, Can.

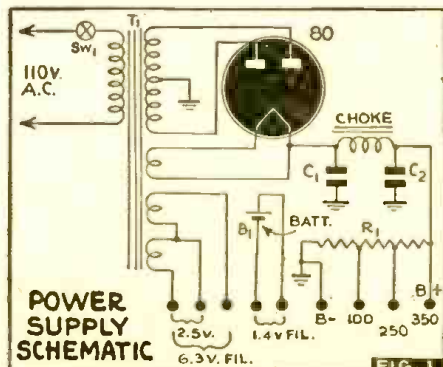

POWER SUPPLY SCHEMATIC

FIG. 1

THE LISTENING POST

Edited by ELMER R. FULLER

FROM the few reports available, it appears that this department is going to fill a long-felt need for many of our readers. This is what we hoped when we started a month ago. If you have any suggestions which you think would make this a still better page, drop me a line, and we will see what can be done with your ideas.

Reception for the past month has been fairly good, with a few very good times occurring now and then. On the whole, nothing out of the ordinary has been heard. The usual summer static conditions have not yet arrived, at least on the east coast. A few storms have bothered a few times, but it has been better than it will be later when it becomes warmer.

With equipment built and installed by RCA, a new 50,000-watt short wave station is on the air at Rio de Janeiro, Brazil. It is known as "Radio Nacional" and broadcasts nightly, beamed to North America,

on a frequency of 26.5 mcs. As yet we have not heard any reports of its being heard.

The British Broadcasting Corporation has announced a new program beamed to Europe, and with increased power. "These moves are part of the Allied offensive strategy for 1943 and in weeks to come BBC European service will act as a direct link with the Allied High Command on the Continent," was London's assertion in making the official announcement. "London calling Europe" is now heard at 9 am and 4:45 pm on 9.69 and 9.51 megacycles. News in German is on the hour and in French on the half hour.

In the North American service, the BBC now gives the news in English at 5:45, 6:45, 9:06, and 10:45 pm; and 12:30 am. Complete summer schedules will be found under the station lists in this issue.

A station in Algiers, using the call AFHG, is now being operated by the Al-

lied Forces in North Africa. It has been heard from 8 to 9 am on 16 mcs.; 1 to 5 pm on 12.12 mcs.; and early evenings on 8.96 mcs. The schedule of news to North America will be found under the station lists.

XGOY, in Chungking, China, now broadcasts the news in twelve languages, including Chinese, English, Cantonese, Russian, Japanese, Spanish, Annamese, Burmese, Dutch, French, Siamese, and Malayan. Three frequencies are used, 7.171 mcs.; 9.635 mcs.; and 15.2 mcs. The North American beam is used from 10 to 11:30 am. This information was furnished by Ying Ong, of Phoenix, Arizona.

For our readers who are news-hounds, here is a list of the times of war news broadcast in English. May we warn you to beware of propaganda, however, when listening to stations, especially those operated by our enemies.

Time	City	Station	Frequency	Time	City	Station	Frequency	Time	City	Station	Frequency
7:00 am	London	CSB	9.51	2:00 pm	Tokyo	JLG2	9.505	9:00 pm	Tokyo	JLG4	15.105
7:30 am	Berlin	DJB	15.20	3:30 pm	Havana	COK	11.623	9:06 pm	London	GSC	9.58
7:30 am	Vichy	17.765	4:45 pm	London	GRG	11.68	9:15 pm	Moscow	15.11, 9.565
7:40 am	Moscow	9.545, 10.445	4:45 pm	Vichy	9.62	9:45 pm	Madras	VUM2	7.30
8:00 am	Melbourne	VLG2	9.54	5:10 pm	Ireland	9.595	10:00 pm	Berne	HER3	6.165
8:30 am	Manila	KZRH	11.615	5:15 pm	Moscow	15.11	10:00 pm	Berne	HER5	11.865
9:00 am	London	GRE	15.39	5:45 pm	London	GSC	9.58	10:00 pm	Rio	PRL8	11.27
9:15 am	Lahti	OIX3	11.785	6:00 pm	Rome	2RO6	15.30	10:30 pm	Rome	2RO3	9.63
9:30 am	Berlin	DJB	15.20	6:40 pm	Algiers	AFHQ	8.96	10:45 pm	London	GSC	9.58
10:00 am	Chungking	XGOY	7.171	6:45 pm	London	GSC	9.58	10:45 pm	London	GSL	6.11
10:00 am	Rome	2RO6	15.3	6:48 pm	Moscow	15.11, 15.23	11:00 pm	Berlin	DXJ	7.24
11:00 am	London	GSF	15.14	7:00 pm	Berlin	DXJ	7.24	11:45 pm	Brazil	FZI	11.97
11:00 am	Stockholm	SBT	15.155	7:00 pm	Tokyo	JLG4	15.105	12:00 mid	Berlin	DXJ	7.24
11:00 am	Melbourne	VLG	9.58	8:05 pm	Madrid	EAQ	9.86	12:00 mid	Berlin	DXP	6.03
12:00 pm	London	GRE	15.39	8:30 pm	Rio	PSH	10.22	12:30 am	London	GSC	9.58
12:30 pm	Tokyo	JLG2	9.505	8:30 pm	Rome	2RO3	9.63	12:30 am	London	GSL	6.11
12:30 pm	Berlin	DJD	11.77	9:00 pm	Berlin	DXJ	7.24	1:10 am	Melbourne	VLG3	11.71
2:00 pm	London	GRE	15.39	9:00 pm	Mexico	XERQ	9.615	1:30 am	Berlin	DJD	11.77

With the coming of summer months, many stations have announced changes in their schedules and many more will be changing in the near future. We will try to keep you informed of these changes so that you will know where and when to find what you wish to hear. This station list will be revised monthly, and will be kept as

accurate as possible. However, many times stations change their programs and schedules on short notice, and sometimes without notice. These of course cannot be noted in our station lists. Many new stations have been added since last month, and some have changed their schedules completely.

We are seeking information in regard to

the schedules of the Russian stations. Anyone having this information, will they please forward it to me? I shall be glad to receive reports on the stations which you hear and will give credit for all reports received. Please address me: Elmer R. Fuller, c/o Radio-Craft, 25 West Broadway, New York City, U.S.A.

Mcs.	Call	Location and Schedule	Mcs.	Call	Location and Schedule	Mcs.	Call	Location and Schedule
26.5	—	RIO DE JANEIRO, BRAZIL; Radio Nacional; nightly to N. A.	15.270	WCBX	BRENTWOOD, NEW YORK. European beam, 6 am to 4:30 pm. Rio beam, 5 to 7:45 pm.	15.150	WNBI	BOUND BROOK, NEW JERSEY. European beam, 8 am to 5 pm daily.
17.840	—	ATHLONE, IRELAND. "Radio Eireann." 8:30 to 9:30 am, 1:30 to 2:15 pm.	15.260	BBC	MANCHESTER, ENGLAND. African service. Heard Monday 4 pm.	15.129	—	ATHLONE, IRELAND. "Radio Eireann." 2:30 to 5 pm.
17.830	LRA5	BUENOS AIRES, ARGENTINA. Afternoons.	15.250	WLWO	MASON, OHIO. Latin American beam 5:30 to 7 pm.	15.105	JLG4	TOKYO, JAPAN. 7 to 9:30 pm.
17.830	WCRC	BRENTWOOD, NEW YORK. European beam, 6 am to 5 pm. Buenos Aires beam, 5:30 to 7 pm.	15.210	WBOS	BOSTON, MASS. 3 pm.	14.925	PSE	RIO DE JANEIRO, BRAZIL. "Hora de Brazil" North American beam. Daily 7 to 8 pm.
17.800	WLWO	MASON, OHIO. European beam, 10 am to 1 pm.	15.200	DJB	BERLIN, GERMANY. North American beam, 5:50 pm.	12.455	HCJB	QUITO, ECUADOR. "La Voz de los Andes" (The Voice of the Andes) in English daily at 8 am and 6 and 9 pm. At other times in Spanish.
17.780	WRCA	NEW YORK CITY. European beam, 9 am to 12:45 pm, daily.	15.200	XGOY	CHUNGKING, CHINA. Asia-Australia—New Zealand beam, 6 to 8:30 am; East Russia beam, 6:30 to 7 am; Japanese beam, 7 to 7:30 am.	12.110	TPZ	ALGIERS. (Probably discontinued. See AFHQ.)
15.980	AFHQ	ALGIERS; 8 to 9:45 am.	15.190	OIX4	LAHTI, FINLAND. 1:15 am.	11.893	WRCA	BOUND BROOK, NEW JERSEY. European beam, 1 to 4:45 pm, 4 to 8:45 am;
15.850	WCW	European beam, 6:45 to 9 am, 5:15 to 6:15 pm.	15.170	TGWA	GUATEMALA. 12:45 pm.			
15.350	WRUL	SCITUATE, MASS. European beam, 7:15 to 9 am.	15.155	SBT	MOTALA, SWEDEN. 12 to 2:15 pm.			

(Continued on page 566)

RADIO KINKS

SOLDERING IRON CLEANER

I learned how to keep a soldering iron clean from a friend of mine, which has worked out very well.



It consists of an old soldering paste can with some steel wool and soldering paste mixed in it. When you insert the soldering iron point and give it a few twists, the corrosion disappears, and the point is clean for soldering.

WILLIAM WAELDER,
Queens Village, N. Y.

SOLDERING IRON STAND WITH HEAT CONTROL

Radio servicemen and experimenters will find this soldering iron stand useful. When you put your iron on it, the heating current is reduced, so that the iron cannot overheat.

The stand consists of two supports and a switch aligned on a bench or a small board. When the iron is on the stand, the switch opens. The soldering iron is plugged into the outlet shown in the diagram. When

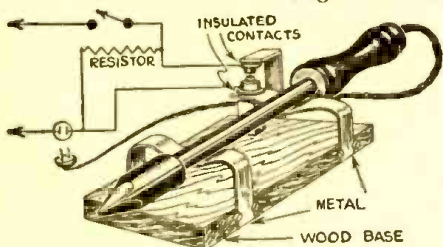

the switch opens, the heating current is lowered by the resistor.

A reduction of the power consumption of the iron to three-fourths of its normal value is sufficient to prevent overheating. If used on a 115-volt line, the value of the resistor should be 2,000 divided by load ohms. The resistor should have a nichrome element, and must be capable of a load of one quarter load watts.

A switch was made of silver contacts from an old car radio vibrator, and a clock spring.

Care should be taken that the contacts are properly insulated from the other parts of the stand.

MARTIN G. REDLICH,
Pullman, Wash.

SIGNAL TRACER

Every short-wave experimenter gets a set to repair every now and then. He merely uses this signal tracer to track down the trouble to the stage which is causing it. Merely locate the control grids of the exploring lead to each of the tube grids, one grid at a time. The ground should connect to the set's ground post.

Going from tube to tube until he can't hear the broadcast station, the defective stage is found. When you get to the stage

Do you have any interesting and novel kinks which you would like to bring to the attention of RADIO-CRAFT readers? If so, send them in addressed to the Kink Editor. A seven-month subscription to RADIO-CRAFT will be awarded for each kink published.

where you can't hear the signal you know this stage is not receiving the signal from the broadcast station, so you can look for your trouble in the grid circuit of this stage, or in the stage before this one.

The switch Sw.1 is thrown to position 1 for testing radio-frequency stages, and posi-

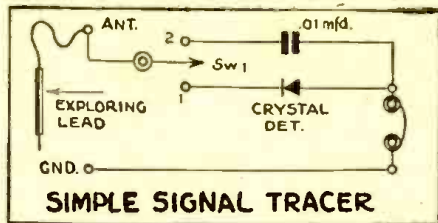

tion 2 for the audio stages. The same procedure is used for both audio and R.F. stages. Remember that switch must be in position 1 for R.F. tracing, and in position 2 for checking audio stages.

This signal tracer can be used to check other items, such as regeneration stages, and gain per stage.

FRED SPIENTZ,
Woodhaven, N. Y.

WATTAGE METER

Having need for a wattmeter with which to test refrigerators, I was ready to buy a commercial instrument when the circuit illustrated occurred to me. I had a Supreme volt-ohm-milliammeter which I no longer used on my test bench, so by winding 20 turns of No. 18 cotton-covered wire on the outside of a small filter choke, and adding a connecting cord, a plug, and receptacle

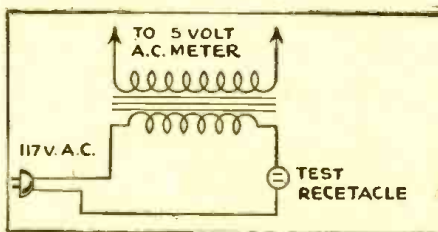

leads as shown, and mounting the assembly in the analyzer case, I had a wattmeter for only a couple of hours' labor. The meter reads 1000 watts full scale on the 5-volt

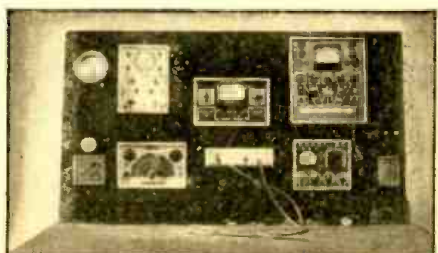

range. Accuracy is sufficient for practical purposes.

The picture shows my test bench and apparatus consisting of an oscilloscope, an electronic voltmeter, a signal generator, a condenser checker, an untuned R.F. signal chaser, an ammeter in the 6-volt supply, and a low-range wattmeter, all mounted as a unit and finished in black, trimmed in chrome.

NORMAN MAXWELL,
Clare, Mich.

MATCH STICK COIL FORM

There are many set builders who find the regular tube base too small to wind a good size coil on. I thought up a scheme which would allow a tube to be used.

Obtain several used matches and flatten each side of each match, about an inch from one end, and glue to the tube base. Try to space them apart as evenly as possible. Allow the glue to dry, then drill the holes required for the coil leads in the tube base. The coil form is then ready to use.

To make the coil form so it can hold more turns of wire, lollypop sticks can be used.

LOGAN B. LAWSON,
Louisville, Ky.

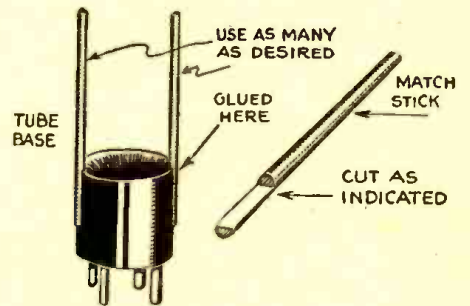

A PRACTICAL, SENSITIVE OHMMETER

When measuring coils and other inductors whose resistances are of the order of one ohm or less, the short-wave experimenter often finds that the ordinary commercial ohmmeter is not sensitive enough. The circuit diagram shows how a current-reading meter may be converted into an ohmmeter of the desired type.

A microammeter is best for the purpose and should it be, for instance, of the two-range variety, work it at its less sensitive, i.e., its shunted, position, to reduce the meter circuit resistance to a low value. This is highly desirable in order to keep the ratio of the unknown resistance to that of the meter circuit as high as possible, for it can readily be appreciated that if the resistance of the circuit ABCDEFA were zero, a resistance, however small, placed across CD would practically constitute an open circuit. (And when one has developed an ohmmeter to which a one-ohm resistance would appear as an open circuit, he's really "got something there.")

While it is possible to increase the line current and decrease RI and the meter shunt resistance to attain a much higher ratio, the constants chosen have been considered for practicability. With these values the two-ohm mark falls to the left of the

center of the scale, making possible the detection of values as low as 1/500-ohm.

The procedure is necessarily simple, for with approximately half of R2 out of the

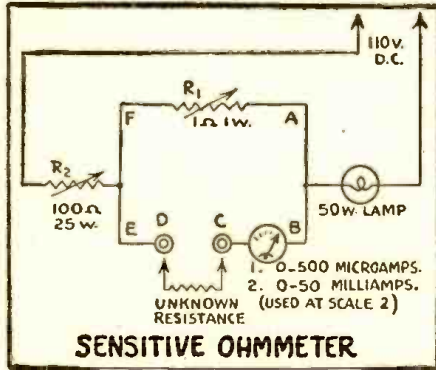

circuit and the prods shorted, it is necessary only that R2 be adjusted to give the meter a full deflection. Then calibrate, using standard resistances. Connections should, of course, be short, and the prod leads should not be longer than necessary. R2 should be left set, voltage compensation being effected with R2.

M. C. LEDESMA,
Milwaukee, Wisconsin.

HANDY TESTER

Practically every experimenter has a power supply which he keeps in the work shop for testing receiver circuits, experimenting, etc. To increase the utility of this power supply, wire a small neon light in series with the 250-volt terminal and arrange a pair of alligator clips in series with the neon lamp and the power supply.

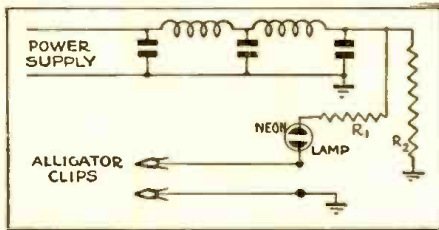

This makes an admirable condenser tester, and an equally good continuity tester, because it is extremely sensitive.

I used a 1/4-watt neon lamp and a 60,000-watt resistor R1 of the diagram for protection against short circuits. R2 is the bleeder resistor of the power pack.

A good condenser when connected in the circuit, will cause the glow lamp to flash once. A leaky condenser will cause it to flash intermittently. An open condenser will cause no flash.

MATTHEW MASTERS,
North Tonawanda, N. Y.

DRIVER TRANSFORMER

I needed a driver transformer, and due to the fact that it was too expensive to purchase, I devised one.

I took two chokes (cheap type) with relation 2:1. I took off the iron that forms

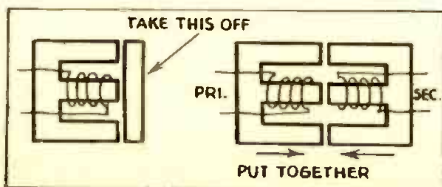

a bridge in the chokes and put them together but opposite to each other, tightening them with elastic.

The transformer was for an audio oscillator.

CESAR DUANY,
Havana, Cuba

CODE OSCILLATOR—RELAXATION TYPE

Illustrated here is a simple but efficient code practice oscillator, which is ideal for code classes because it uses no transformer and does not require a tube and its filament supply. The note is not quite a sine wave, but it is very easy on the ears as there are melodious overtones.

The circuit is a relaxation oscillator which is almost foolproof. Some bulbs will work better than others and on the whole argon bulbs will be found to oscillate more readily than neon ones. If the lamp lights,

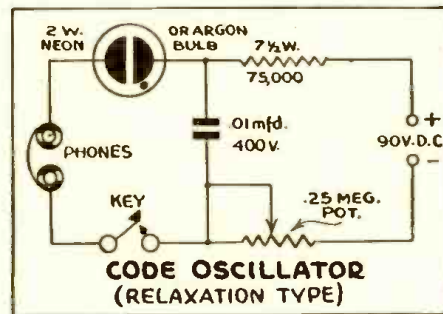

but no oscillations occur, increase the value of the potentiometer in small steps until the oscillations do occur. If the light goes out before oscillations occur, try a new lamp or more voltage. The current drain is very small, so small "portable" type "B" batteries can be used. Even these will last almost indefinitely.

ROBERT HAUPE,
San Fernando, Calif.

IMPROVED TONE

The tone of any set using a No. 42 output tube can be improved and at the same time its output can be increased to 4 watts by simply replacing the No. 42 with a No. 6B5 and grounding the cathode prong of the socket.

That is all there is to it! The 6B5 matches

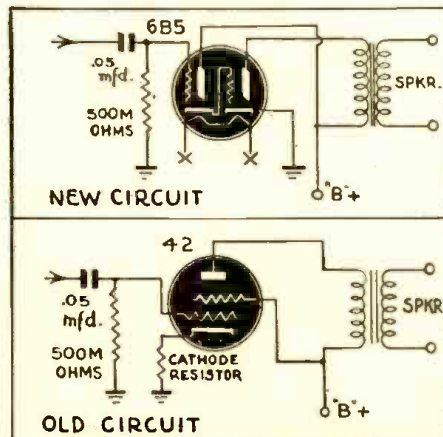

the same speaker and fits the same socket, also draws the same amount of current.

JAMES LIMBECK,
Glendale, Calif.

REPAIRING PHONE TIPS

When the phone tip ends break off or pull out, clean out the old remaining braid which is in the tip by heating on the side with a soldering iron.

Take the wires, cut them off neatly, i.e. the

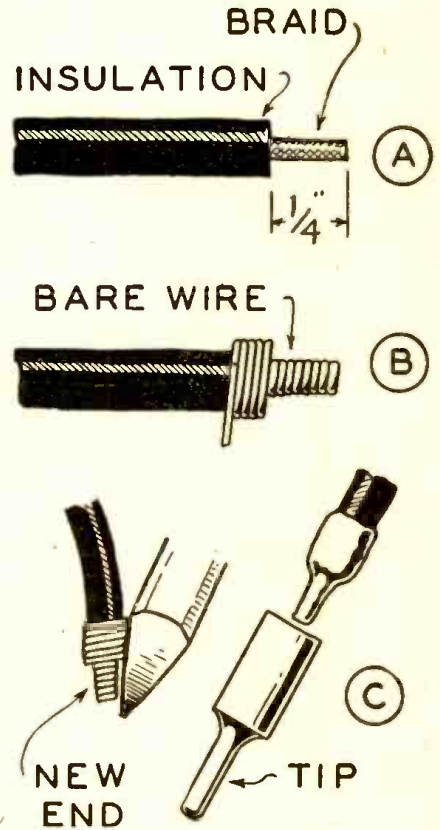

insulation and the braid. Then with a sharp razor cut off the insulation so that 1/4 inch of the braid shows.

Clean the wire braid so it can make good contact. Then take some bare wire about No. 36 or No. 40 (similar to the windings of some coils), wrap the wire around the end of the insulation, and continue to the end of the wire braid.

LESLIE G. McCracken, Jr.
Philadelphia, Pa.

SPEED CHANGE GADGET

Having a phono turntable of 78 r.p.m. and wishing to try out some electrical transcriptions, I devised the speed changer shown to get the required 33 1/3 r.p.m.

A cardboard tube from one of the New Year's calendars was cut to 12 inches long. It was then wound with hook-up wire, and a piece of pipe was inserted in the end. The pipe should be a snug fit.

As the pipe is inserted the turntable will slow down and one can get any speed needed. This cannot be done with all motors.

EDWARD CHRISTNER
Middletown, Ohio

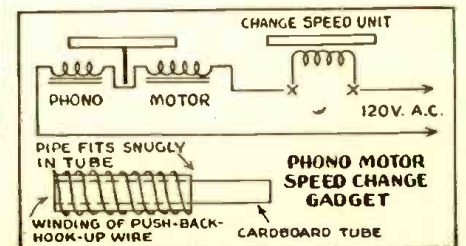

• LATEST RADIO APPARATUS •

PRECISION COIL-TURN COUNTER

General Electric Co.
Schenectady, N. Y.

THIS new coil-turn counter has an accuracy of one turn in a thousand for coils having air cores at least $\frac{3}{8}$ inch in diameter, an outside diameter of less than 8 inches, a coil build-up to $2\frac{5}{8}$ inches and up to 6 inches in height. Accuracy is not as high outside these limits.

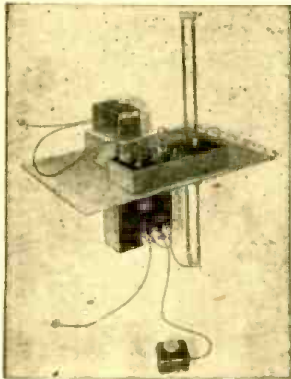

The operation of the counter is simple. The coil to be tested is placed over the test rod and connected to test clips. The dials on the galvanometer control panel are set to the number of turns the coil should have, and the foot switch is pressed. If the galvanometer dial shows a deflection, the dial readings are increased or decreased till the deflection is zero. The dial reading is then the number of turns. When the probable number of turns is not known, a trial reading is taken and the dial is adjusted until the reading is zero on the galvanometer.

Employing the same efficient circuit as its predecessor, the new counter is more compact in design and incorporates a magnetizing current control box which greatly simplifies the installation. The counter is capable of checking or determining the effective turns of coils ranging from 1 to 11,110 turns, at a rate of from 80 to 100 coils of like specifications per hour.

In addition to the magnetizing current control box, the new coil-turn counter comprises a portable light-beam galvanometer, two yoked test rods, a galvanometer control panel, and a foot-operated switch—all conveniently assembled for operation on a table or bench.—*Radio-Craft*

FEED-THRU TERMINAL BLOCK

Curtis Development & Mfg. Co.
Chicago, Illinois

THIS new multiple terminal block, for sub-panel and chassis construction, with feed-through terminals, is designed to meet present-day demands of electronic and electrical design, which require external terminals, because of their wiring simplicity and other advantages.

The terminal block consists of individual feed-through terminals, mounted in bakelite, which are permanently held in a metal strip in any combination desired. Factory production now includes blocks having any number of units between 1 and 10, but, because of their unique sectional design, blocks can be supplied with any number of terminals needed.



Terminals have ample clearances and leakage distances for circuits carrying up to 300 volts, 20 amperes. Center to center distance between terminal units is $\frac{5}{8}$ ". No. 8 screws are used on each side of the terminal units for securing connection. The two mounting holes at each end of the terminal base take No. 8 machine screws.—*Radio-Craft*

MOLDED PAPER CONDENSERS

Micamold Radio Corporation
Brooklyn, N. Y.

THESE newly developed small capacitors, known as Type 338, have body dimensions $\frac{3}{4}$ inch long by $\frac{7}{16}$ inch wide and $\frac{7}{32}$ inch thick, and is supplied in capacities up to .01 mfd. The rated working voltage is 120, D.C.

Because it is hermetically sealed, the 338 will operate satisfactorily under highly humid conditions.—*Radio-Craft*

CATHODE RAY OSCILLOSCOPE

Radio City Products Co.
New York, N. Y.

THE Model 553, 3" Cathode Ray Oscilloscope, is an extended frequency 3" oscilloscope with greater sensitivity.

Its compactness, limited weight, and sturdy construction makes it a desirable portable field instrument. The power consumption is made low enough for field work. All controls and terminals are located on the front panel. Switching arrangement permits applying input either directly to deflection plates or to input of the amplifier. Position and stable locking of the image can be obtained with either the vertical signal or any external signal.

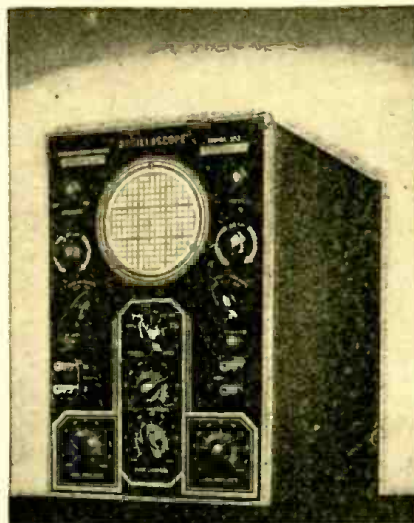

The high gain amplifiers use television tubes for maximum sensitivity.

The built in sweep has the greatest range consistent with good linearity.

General Specifications:

Power supply, 110-120 volts; 50-60 cycles. cycles.

Power consumption, 50 watts.

Fuse protection, 1.0 amps.

Input impedance, through either amplifier, 5 megohm 20 mmfd.; without amplifier, 2.2 megohm, 40 mmfd.

Deflection sensitivity, through either amplifier (max. gain) .6 r.m.s. per inch; without amplifier, .35 r.m.s. per inch.

Amplifier frequency response ± 3 db, 20, 100,000 cycles.

Linear time-base, frequency range, 15, 22,000 cycles; synchronizing signal sources, internal, 60 cycles.—*Radio-Craft*

A MEGOHM DECADE BOX

Shallcross Mfg. Co.
Collingdale, Penna.

THE Shallcross No. 915-A Megohm Decade Box is a single dial box, consisting of ten 1.0 megohm resistors, connected in series, mounted on steatite insulators. These accurate resistors are thoroughly impregnated so that the calibration is not affected by high humidity. Each resistor is capable of dissipating two watts; however, in work requiring closer tolerance the dissipation



should be held to one watt per unit. The resistors have a standard accuracy of $\pm 0.05\%$ at 74° F.

This No. 915-A Megohm Decade Box is housed in a metal box; may be furnished completely shielded. The unit may be immersed in an oil bath, for work demanding extreme accuracies, increased dissipation or both. A maximum of 10,000 volts may be applied across the binding post.—*Radio-Craft*

TANDEM POWER RHEOSTATS

Clarostat Mfg. Co.
Brooklyn, N. Y.

THESE assemblies are made up of two 25-watt or two 50-watt rheostats rigidly coupled together and held in a metal cradle. The usual one-hole mounting and locking-projection features are retained. The individual rheostats can be of any standard resistance value, taper, tap and hop-off, and all units go through the same degree of rotation as the single shaft is turned. The units are fully insulated from each other and from ground. Because of the wide choice of resistance values and other factors, such assemblies are necessarily made only on special order. This type of control finds a wide range of uses in electrical and industrial applications, where, dependent on the special applications, they make for greater economy, safety or convenience.—*Radio-Craft*



SUPERREGENERATOR ALMOST MISSED

MANY an inventor, his faculties concentrated on the object of his search, has noted and then passed by discoveries which have brought fame and fortune to later discoverers. The fields of chemistry and metallurgy can show more than one instance where millions of dollars worth of valuable products were thrown aside in recovering substances worth one-tenth as much as the discarded and unrecognized "by-product."

Such was the experience of Edison, who, while searching for a better electric lamp filament, discovered the principle underlying the action of all present-day radio tubes. He noted the action and went on seeking better filament materials. Later Fleming and DeForest developed the "Edison effect" into the tubes which make possible our modern Age of Radio.

Years ago producers of coke were troubled by the accumulation of enormous quantities of coal-tar. Unkind authorities prohibited dumping it in the rivers. It killed the fish. Carting it away was one of the expenses that took the profits out of the coke business.

Today coal tar is one of the central products of chemistry. The names of its uses alone would make a fair-sized book. Coke is now a by-product, useful, but sometimes presenting a disposal problem because of a limited demand.

The experience of Tesla was somewhat different. He discovered, recognized and patented principles far ahead of the science of his times. By the time the art had advanced far enough to utilize his discoveries, his patents had run out.

It is one time in a thousand that an inventor passes by a new and important development—then later rediscovers it himself before some later worker has found it and reaped the profits of invention. Such a person is Major Edwin H. Armstrong, inventor of regeneration, super-regeneration, the superheterodyne and most recently, frequency modulation or FM.

Major Armstrong's story came out in an address to the A.I.E.E. on the occasion of his receiving their award for the most outstanding radio work of 1942. He admitted that he had designed a super-regenerative circuit in 1915, but that neither he nor anyone else had recognized that fact till long after he had re-discovered and publicized the super-regenerator in 1920.

The 1915 super-regenerative circuit appeared in a paper on "regeneration" which was published at the time. Read by thousands of engineers and experimenters all over the world, nobody reported any new or strange features.

Later, in 1920, it was necessary to dispute in court the question of who was the first to use regeneration. While working on a set-up to be used in court to demonstrate the Major's priority rights, some remarkable effects were noticed:

"Suddenly other signals of a most unusual character came in," the inventor told the A. I. E. E. "My first thought was that a British cruiser was near by in the North River, since the tone of the signal was somewhat akin to their double-tone spark note and the strength so remarkable. Then it was observed from the character of the messages that the signals were from the Brooklyn Navy Yard. Other well-known stations also came in with a strength hundreds of times greater than any regenerative circuit would give.

A NEW PRINCIPLE WAS BORN

"As it gradually dawned upon me that some new principle of amplification was

being observed, the nature of which I couldn't even guess, the effect disappeared and could not be reproduced—only the feeble response of a simple regenerative circuit was left. Nothing I did would make it behave in other than a quite conventional manner. Five minutes before I would have sworn to the high heavens that I understood all there was to know about regeneration. Five minutes only were required to wipe out that complacent belief engendered by nearly a decade's work."

"Some completely bewildered experimentation" restored the effect, until it could finally be maintained long enough for examination. Then he went to work to "discover the principle." More work brought to

light a principle quite beyond the bounds of his wildest dream, "the existence of which had never been suspected and therefore quite unlikely to have come from purely analytical means."

In 1935, 15 years after he supposed he had invented the super-regenerative circuit, Major Armstrong was looking over the old paper on regeneration published in 1915. He noted that among the several circuits that had been included, one was undoubtedly a super-regenerator.

"The original apparatus, then still intact, was set up," he said, "and 'super-regenerated' beautifully. It is seldom that one escapes the penalty for a blunder such as this."

DEPENDABLE COILS!

Meissner coils have, for many years, been the accepted standard by servicemen who insist upon high quality performance . . . Meissner precision coil construction never varies . . . they are the best that engineering research and modern production methods can make.

When you specify a Meissner coil you have the assurance of long, trouble-free operating life . . . backed by a name that is synonymous with precision-built electronic products.

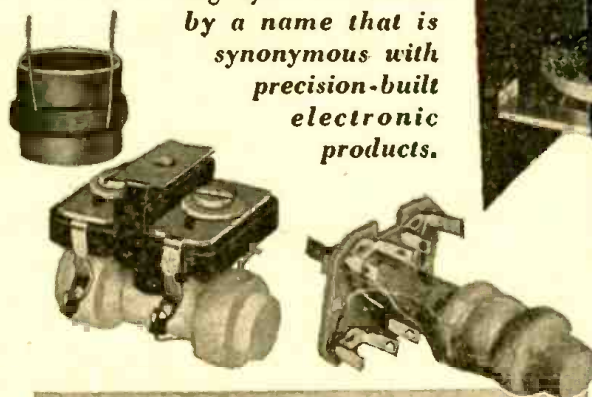

Meissner
MT. CARMEL, ILLINOIS

"PRECISION-BUILT ELECTRONIC PRODUCTS"

NEVER TAKE IT FOR GRANTED!

(Continued from page 530)

tuning in a good swing band for your test signal. You hook your signal tracer to the diode plates of the second detector, setting the reading for same. Soon the volume increases and upon inspection you find that the signal at the diode plates is somewhat greater—but the A.V.C. voltage is considerably lower! Later the volume of the receiver drops down and we find that the A.V.C. voltage has increased.

"Something screwy there," you think. "The stronger the signal is at the diode plates the more A.V.C. voltage I should have." And then you start replacing tubes, one at a time, in the A.V.C. controlled sockets. You'll probably find one tube which, due to gas or some other defect, cancels out the

A.V.C. voltage at times, thus increasing sensitivity of the receiver. And that tube tests pretty good in a tube tester!

Sometimes, however, you may replace each A.V.C. controlled tube and your trouble still persists. At such times you'll probably find the A.V.C. voltage is leaking off through a defective (but tests good) by-pass condenser. Usually the low end of each grid winding (Antenna coil, R.F. coil, and I.F. coil) has a small by-pass condenser connected from it to ground. By clipping one of these condensers at a time you may find one that, by being disconnected, returns your A.V.C. voltages to normal. That's the one you must replace. Could you have found a defect like that with a "screw driver and a

few little things?"

Another test for bad tubes that the tube tester won't show up is this: turn on the volume control to its maximum position. Have the antenna and ground disconnected entirely. Now tap each tube with the eraser end of a pencil. You'll find lots of noisy and intermittent tubes with this system that would cause plenty of grief—possibly after your customer had his radio back home and was hoping for perfect reception.

Never take it for granted that, because you don't have in stock some particular type tube, you can't fix up the man's radio to serve him well. Of course the various substitution charts will help. There are, however, several tubes that are not available and several that cannot be substituted.

BE A RADIO TECHNICIAN



GET ON TECHNICAL FRONT

Millions of war workers were thrown out of their jobs after World War I. It may happen after this war. When millions of workers now making shells, tanks and war munitions scramble for peacetime jobs YOU can be secure in a job in the highly paid RADIO Industry or its branches. But you must do something about it NOW, while you have the chance!

FREE TRIAL LESSON
proves
you can learn
quickly

Top Pay
During the
War
Security
After the
War

GET INTO AN INDUSTRY THAT IS BOOMING

Television and Electronics, now perfected, promise to be the boom post war industry that will give employment to thousands of trained men. The Radio and Electronics Industries need trained men now. Over 10,000 establishments design, manufacture, purchase and sell \$1,000,000,000 worth of equipment every year. Radio-trained Technicians are needed today as well as after the war.

SHOP METHOD HOME TRAINING

fully qualifies you for bigger pay jobs



QUALIFY FOR THESE JOBS

- Radio Expert
- Broadcasting
- Aircraft—Marine
- Indust. Electronics
- Studio Technician
- Gov't. Service
- Remanufacture

Keep your present job. Train yourself at home during your spare time. Learn this easy, progressive, fascinating way. For 28 years National Schools, the largest trade school in the West, has trained thousands of ambitious men in its well-equipped shops in Los Angeles. But because so many men wanted this training and could not leave their jobs in distant localities, National's instructors developed this marvelous Home-Training Course. It virtually brings the shops and laboratories to you, no matter where you live. You get the same technique and shop methods successfully used in training thousands of National graduates. Today many of them hold lucrative positions high up in the Radio Industry.

MANY MILITARY MEN NOW ENROLLED

As in Industry, Radio Technicians are of course in great demand by the Armed Forces. Soldiers, Sailors and Marines get interesting assignments, higher ratings and better pay. Out of uniform after the war they, too, will step into high-pay Radio Technician jobs.

A FEW OF THE SUBJECTS COVERED IN YOUR TRIAL LESSON

In order that you may see how easily and quickly you can learn Radio in the National Way, we give you a Trial Lesson, including:

1. How to identify the various stages of a receiver.
2. How to check power supplies.
3. How to locate a faulty r-f. detector or audio stage.
4. How to check the oscillator and i-f stages in superheterodyne receivers.
5. How to measure voltages at tube sockets.
6. Handy reference table covering the most common receiver troubles—such as causes for a "dead" receiver, weak reception, etc.

You can learn while earning. Men of all ages are enrolling.

A Penny Postal May Start Your Radio Career

Do this for yourself. Mail the Coupon below and find out how you can keep your present job and at the same time easily train yourself at home for a better position during the war and an assured future after the war. We'll send you absolutely free and without any obligation the informative Book, "Radio Opportunities" and a Trial Lesson, with our compliments.



NATIONAL SCHOOLS

Los Angeles California

ESTABLISHED 1903



MAIL OPPORTUNITY COUPON FOR QUICK ACTION

National Schools, Dept. RC-6 (Mail in envelope or 4000 So. Figueroa, Los Angeles, Calif. **postage penny paid**)
Mail me FREE, without obligation, one Lesson and Opportunity Book, with full details about how I CAN become a RADIO Technician.

NAME _____ AGE _____
ADDRESS _____
CITY _____ STATE _____

— THE START TO SUCCESS COUPON

TUBE SUBSTITUTIONS

Is your stock of 50L6 tubes exhausted? (Whose isn't?) You can use type 35L6 with a resistor of 60 ohms in series with it—provided you have a 35L6! For those of us who have neither type the scheme pictured above (diagram No. 2) works like a charm. In a 5 tube receiver very few changes in the original wiring are necessary, and a line cord resistor is the only new part required to make a type 25L6 tube work in the socket originally occupied by the 50L6 (or 35L6). The three twelve-volt tubes are always already wired in series. Hook up the 35 volt rectifier tube in parallel with this three tube series. That gives us the equivalent of a 36 volt tube drawing .3 amps of current for its filament. As the 25L6 also draws .3 amps it can now be hooked up in series with the network just constructed. Be sure to clip the wire between the 35Z5 plate and filament. Now wire in a line cord resistor of around 180 ohms as per diagram and, presto, you have someone's AC-DC midget ready to roll in more war news. For a six tube receiver wire as per diagram No. 3, wherein one new six volt, .3 amp tube is inserted in place of the 12 volt tube originally in the receiver.

No changes whatever need be made in the wiring of other circuits since, except for filament ratings, the 25L6 is practically identical to the 50L6. Of course, if the 25L6 (25L6GT) is unobtainable, the old type 43 could be used by drilling out the socket and replacing with the standard six prong socket. But, since plate load requirements are quite different, a new output transformer would be required—also a new value of bias resistor. The author has had little difficulty in keeping a stock of 25L6GT tubes. If your regular distributor doesn't have them try some of the larger radio wholesalers of Chicago or New York.

An old line cord resistor is a mighty good thing to have around. You will find a number of uses for low resistances with high wattage ratings. Just cut out a piece to cover your requirements. Many type 35Z5GT tubes have been thrown away with only the filament open between prongs 2 and 3 (pilot lamp tap). Merely twisting the pilot lamp wires together makes such a tube operative again but, of course, kills the pilot lamp. But hooking a piece of line resistor of about 30 ohms between prongs 2 and 3 on the socket will restore both the tube and pilot lamp to operation.

REPLACING THE 14-VOLTERS

A short time ago a man brought in a new model Zenith (AC-DC). This particular model uses the new 14 volt local tubes. A type 14R7 was burnt out. The 14R7 is a duo-diode-pentode and was used in this particular circuit as the combined I.F. stage

TECHNICAL BULLETINS

Technical bulletins give reliable information in easy-to-follow form, and save valuable time otherwise spent in laborious reading of numerous books. Every subject is treated briefly and concisely, yet completely. No complicated mathematics, chemistry, electricity, or theory. Each bulletin is written in simple language.

Each Bulletin consists of a set of large sheets, assembled in one packet, size 9 x 14½"; weight ¼ lb. Numerous illustrations, diagrams, charts to supplement text.

PRICE \$1.00 EACH POSTPAID
ORDER BY NUMBER

- D-111—DESIGNING AND BUILDING TRANSFORMERS
- D-112—DESIGNING ELECTRO-MAGNETS
- D-113—HOW TO DESIGN SOLENOIDS AND PLUNGER MAGNETS
- D-101—USING NICHROMER RESISTANCE WIRE
- D-106—REWINDING ELECTRIC MOTORS
- D-144—A. C. CURRENT CONTROLLED WITH EASILY MADE CHOKE COILS
- D-148—DESIGNING AND USING ELECTRIC RELAYS
- D-127—SMALL ELECTRIC LIGHT PLANTS
- D-134—ELECTRICAL EXPERIMENTS WITH SIMPLE MATERIALS
- D-131—MODEL MAKERS & INVENTORS GUIDE TO REMOTE-CONTROL SWITCHING
- D-137—ELECTRICAL METERS EASILY BUILT
- D-136—SMALL A.C. ARC WELDER CONSTRUCTION AND USE

—GEOPHYSICAL— PROSPECTING PRINTS (TREASURE FINDERS)

With any one of the modern geophysical methods described in the Blue-Print patterns, radio outfits and instruments can be constructed to locate metal and ore deposits (prospecting); finding lost or buried treasures; metal war relics; sea and land mines and "duds"; mineral deposits; subterranean water veins; oil deposits (under certain circumstances); buried gas and water pipes; tools or other metallic objects sunken in water, etc., etc.

- Folder No. 1
THE "RADIOFLLECTOR PILOT"
- Folder No. 2
THE "HARMONIC FREQUENCY LOCATOR"
- Folder No. 3
THE "BEAT-NOTE INDICATOR"
- Folder No. 4
THE "RADIO-BALANCE SURVEYOR"
- Folder No. 5
THE "VARIABLE INDUCTANCE MONITOR"
- Folder No. 6
THE "HUGHES INDUCTANCE-BALANCE EXPLORER"
- Folder No. 7
THE "RADIODYNE PROSPECTOR"

Each set of blueprints and instructions enclosed in heavy envelope (9½" x 12½"). Blueprints 22" x 34"; eight-page illustrated 8½" x 11" folder of instructions and construction data... **50c**
Add 5c for postage

The complete set of seven folders **\$3.00**
Shipping weight 2 lbs. (add 25c for shipping anywhere in U.S.A.)

Send Stamps, Cash or Money Order

TECHNIFAX

1917 S. STATE ST. RC634 CHICAGO, ILL.

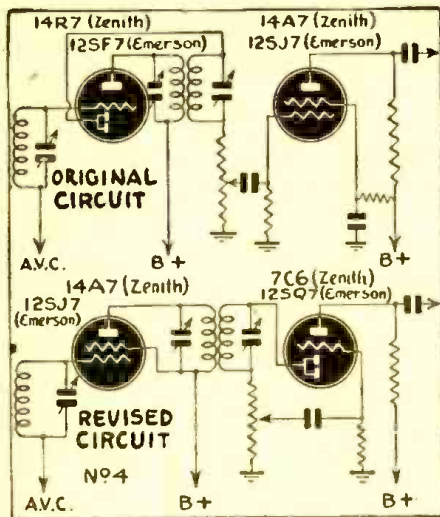

sort of tube drawing .15 amps I rewired two stages of the receiver into what seems to be standard practice—a pentode as the I.F. tube, followed by a duo-diode-triode as combined diode detector, first A.F. stage. A type 7C6 was used (with filament dropping resistor) for the detector-first A.F. stage.

A few days later a girl brought in an Emerson. A type 12SF7 tube was burnt out. I had no such tube. It was used as a combined I.F. tube and diode detector (another duo-diode-pentode). And a type 12SJ7 was used for the first A.F. stage! Exactly the same procedure was necessary as in the Zenith (two stages rewired—I used the 12SJ7 as the I.F. tube, a new type 12SQ7 as the combined diode detector, first A.F. stage). As yet I have still been unable to secure either a twelve volt or fourteen volt duo-diode-pentode. But I can always rewire those two circuits!

An article with a title like this has unlimited possibilities. Page after page could be turned out on troubles you will encounter that are not strictly "according to the book." The author hopes these few instances quoted above will help some few servicemen in their various problems. Remember, *the only thing you can take for granted in radio servicing* is that your customer—parts and tube shortages notwithstanding—expects you to KEEP 'EM FLYIN'.

and diode detector. A separate first A.F. tube was another 14 volt local, type 14A7. The owner of this radio said he had already been to several repairmen in other towns and they told him the tube was not available and that no other could be used in its place. Repairing this receiver required the changes shown in diagram No. 4. Having no duo-diode-pentode in any

HOW METERS ARE REPAIRED

(Continued from page 531)

each of the different types of instrument springs used at the present time. Arrange these in the order of increasing spring thickness, with one group for voltmeters and one group for ammeters. The lower resistance springs are assigned to ammeters, while the higher resistance ones are assigned to voltmeters. This segregation is necessary to provide the best possible design of both voltmeters and ammeters.

When an instrument is returned with damaged springs remove a portion of the damaged spring from the instrument moving coil and measure its thickness as carefully as possible with an accurate micrometer. This is possible in 90% of the cases

since there will usually be some portion of the spring still on the abutment, even after a severe burnout.

Check to see if the instrument is a voltmeter or ammeter (Millivoltmeters will be classed under ammeters in general) then pick out a spring of the measured thickness from either the voltmeter or the ammeter group.

If, after the new spring is soldered in place, the instrument appears to have a much greater sensitivity than normal, remove one or two turns from the outside of the spring by cutting off the turn and resoldering to the abutment.

THE SERVICING OF 3-WAY PORTABLES

(Continued from page 535)

the high gain possible from the I.F. is obtained. By dressing the plate lead away from the grid wiring and putting it close to chassis the regeneration can be cut out. The grid lead to the tube should be pushed down into the shield can and not left flopping around on the outside where it can

pick up interference. In some sets this doesn't matter and the circuits are not critical, in others it does.

The remainder of the troubles are the more or less common ones found in any A.C.-D.C. receiver.

TONE CONTROLS AND PENTODE TUBES

REFERRING to some recent remarks about the strange habit people have of leaving the tone control in its most "woofly" position when reproducing music, a correspondent suggests that the so-called "pentode shrillness" and spurious high frequencies introduced by these tubes in poorly-designed output circuits may have something to do with it.

The only thing wrong with the argument is that there isn't any "high"—spurious or otherwise—in the kind of set he seems to have in mind. There just isn't, as you can hear by listening to speech. It is completely muffled, and you can't produce shrillness enough to make it "edgy" if you jam the tone control hard over in the treble position.

It must be admitted that there are sets in which the misused pentode output is guilty of horrible crimes. The original

upper audio frequencies are pretty well removed by sideband cutting in the I.F. stage or stages, and a shrill, uncorrected pentode is used in the output to supply a "top" quite unlike that which has been suppressed earlier.

Such sets are impossible on either speech or music, and no amount of juggling with the tone control is likely to do much good.

Pentode output can be excellent if you take a great deal of care over the circuits and are not afraid to pay for components; but the pentode tube offers the designers of cheap sets such a money-saving means of providing considerable volume combined with poor quality of reproduction, that we are sometimes tempted to regret that it was ever invented.—*Wireless World, London*

MICROPHONES ★ PLUGS ★ SWITCHES

GOVERNMENT SPECIFICATION ITEMS

AR-1M	PL-54	SW-141
CU-1	PL-55	SW-217
CU-2	PL-291	CD-318
1700-U	JK-26	CD-508
PL-68	JK-48	M-199

PROMPT DELIVERIES

UNIVERSAL MICROPHONE CO., LTD.

INGLEWOOD, CALIFORNIA, U. S. A.

P.A. suggestions and suggestions to manufacturers.

The writer wishes to acknowledge the fact that he has drawn freely upon the following publications for much of the information contained in this article:

- Proceedings of The I.R.E.
- RCA Review.
- Radio-Craft.
- Radio-World (Out of Print).
- Radio Engineering—Terman—McGraw-Hill.

INDUSTRIAL MUSIC IS SPUR TO PRODUCTION

(Continued from page 537)

more strongly the intangibles which escape exact measurement, but whose influence is felt in ways hardly less important than those shown on the man-hour scale of the graphs. Better general morale, fewer labor-management disputes, elimination of fights among employees, are only some of the benefits which have been reported by enthusiastic customers of sound-service organizations.

THE FIELD IS OPEN

The field here for the local sound-and-service men can hardly be over-estimated. Armed with exact figures as to the gains which may reasonably be expected from the use of a plant broadcast system, he may approach local manufacturers with confidence. Knowing local conditions, he has a certain advantage in selling such installations, as compared with larger and more distant organizations. His advantage continues after the apparatus is installed. It must be kept running without stop. A day's silence due to breakdown shows up in the company returns as a loss in dollars and cents. Thus an on-the-spot serviceman is an essential.

Knowing his advantages, the local serviceman should not overlook the opportunities offered by this type of business. It is profitable from the viewpoint of both sales and service, and builds his prestige with the employees of the industrial plants in which his apparatus is installed, thus serving as the most effective possible means of advertising his business to prospective customers.

FOUR-CONDUCTOR CABLE FOR U. S. SIGNAL CORPS

A CARRIER telephone system which employs a four-conductor cable has been developed by Bell Laboratories in co-operation with the Signal Corps of the U. S. Army. The cable can be buried, laid on the ground or suspended in the air. The system provides three telephone channels, including both voice and carrier frequencies, and four telegraph circuits. Voice frequencies are heard satisfactorily forty miles without amplification. All the channels can be amplified by a single compact repeater. These are spaced twenty-five miles apart and extend the range to 200 miles.

The cables are made in quarter-mile lengths with quick coupling connectors at each end to permit extending a circuit to any desired distance. In each connector one of the pairs of conductors is loaded with small coils developed by the Laboratories. The conductors are made of stranded copper, individually insulated, and formed in a "spiral four." Strength is provided by enclosing the cable in a braid of small high-strength steel wires. A tough rubber jacket completes the four-conductor cable.

This system extends the distance over which telephone communication can be quickly established by our field forces. —Bell Laboratories Record

ELEMENTARY MATHEMATICS

The Book that takes Drudgery out of Mathematics

Only **50c** postpaid

SOLVES EVERYDAY PROBLEMS — HELPS YOU GET AHEAD IN LIFE

CONTENTS OF BOOK

- CHAPTER I. Arithmetic—Addition—Subtraction—Multiplication—Division.
- CHAPTER II. Factoring and Cancellation—Fractions—Decimals—Percentage—Ratio—and Proportion.
- CHAPTER III. The Metric System.
- CHAPTER IV. How to Measure Surfaces and Capacity (Geometry).
- CHAPTER V. Powers and Involution—Roots and Evolution.
- CHAPTER VI. Mathematics for the Manual and Technical Craftsman—Thermometer conversions—Graphs or Curve Plotting—Logarithms—Use of the Slide Rule.
- CHAPTER VII. Special Mathematics for the Radio Technician.
- CHAPTER VIII. Commercial Calculations—Interest—Discounts—Short Cut Arithmetic.
- CHAPTER IX. Weights and Measures—Useful Tables.

Send Stamps, Cash or Money Order.

Send today for your copy of this indispensable book. It can be carried readily in your pocket. (Size 2 1/2 x 9 in.)

ONLY **50c** POSTPAID

TECHNIFAX

1917 S. State St., RC-643, Chicago, Ill.

Complete Plans

For Building Useful and Practical Things at Home. Each issue of Popular Homecraft is crammed with plans for making such beautiful and useful things as: Furniture, Bins, Houses, Lamps, Outdoor Garden Furniture, Condoe Equipment, etc. Covers the work, tools, wood-working, leathercraft, copper. You'll find "how" to make almost everything from the pages of Popular Homecraft. Scores of drawings and photographs make every step simple as A B C. A real "How-To-Do-It" magazine.



Six Months' Trial \$1.00

Send \$1.00 today for trial six months' subscription. Money Back If Not Delighted.

POPULAR HOMECRAFT

837 Palmolive Building Chicago, Ill.

Trial 6 Months \$1.00

PRACTICAL AUDIO AMPLIFIER THEORY

(Continued from page 538)

come about from the reduction of wiring capacity and inductive effects and the alteration of circuit component couples sufficiently to minimize or alter some types of parasitics under certain conditions. In transmitter work, cases have been known where power amplifier circuits have exhibited a dozen varieties of parasitics before they were finally subdued.

CLEANING UP AN AMPLIFIER

In one case where a p.p.-parallel power tube circuit was wired up, it was found that transposition reduced birdies and whistles and left hum and distortion effects. These were then eliminated by inserting grid resistors of about 10 ohms each between the paralleled grids. This would indicate that the transposition eliminated or reduced the regenerative type of parasitic and the grid resistors dampened out the "hunt" type of parasitic between the paralleled tubes.

This brings to mind a tube arrangement which might prove of some interest to "hams." By using top mounting transformers and a "double-decker" arrangement of the p.p.-parallel tube sockets with the sockets ganged up back to back, the paralleled tubes may be mounted one directly above the other with one tube upside down. This would make for extremely short connecting leads. This arrangement plus criss-crossed leads would tend to discourage parasitics and would require much smaller suppressor resistors and therefore less circuit losses.

Shielding of power tubes is strongly recommended as an aid to the suppression of parasitics since tubes are an appreciable source of coupling between circuits, especially electrostatic coupling. Large, well-ventilated shields are necessary in the case of power tubes in order to keep temperatures within reasonable limits.

CONCLUSION

It is hoped that the above article has been of some help to newcomers in the radio and P.A. games and has thrown some light upon the various factors entering into the design, construction and operation of audio amplifier systems.

Two or three more short articles will follow soon which will go into phono pick-ups,

RESONANT COILS AND REACTING CONDENSERS

(Continued from page 540)

175 across the inductor and 35 across the lamp. An attempt to work out the voltages by the triangle method fell flat, probably because of the fact that the inductor was far from being a pure inductance, but formed its own inductance-resistance triangle inside the larger combination. A check on the condenser—the "purest" element in the circuit—showed that we might have expected 290 volts across it, with the 0.54 ampere current through 540 ohms.

Shorting either the inductor or condenser has an interesting result. The lamp goes out at once and the meter reading drops back to 0.22 or 0.1, depending on whether coil or condenser is shorted. It is not often that the serviceman sees a short-circuit that reduces the current flow!

A RESONANT CIRCUIT

To see how far this experiment could be carried on, a number of condensers were gathered up and paralleled across the 5 mfd. unit already in circuit. Using most of the condensers in the junk box, a point was reached where total current flow was 0.66 ampere, voltage across the coil and condenser was 175 volts each, and across the lamp 60 volts.

It would appear that—with inductive and capacitive reactance balanced out—there must be 94 ohms resistance in our coil-condenser combination. This makes a rather sloppy experiment—the writer has seen cases where the voltage across coil and condenser was built up to 600 from the 110-volt line, but has never yet seen one in which there was not a good deal of unexplained resistance in the circuit.

If we go to radio frequencies—where smaller coils and condensers can be used—we can get rid of more of the effects of resistance and get more striking results. Let us try to calculate the voltages and currents in a circuit like that of Fig. 5, where we have a coil of approximately 350 microhenries and a condenser of 200 mfd.

With the help of a ten-cent reactance slide rule, it was found that at 600 kc. the condenser and coil in this circuit each have a reactance of 1300 ohms. Since the two balance each other, only the resistance of the coil and condenser remain in circuit. It is possible, with "low-loss" apparatus, to keep this resistance down well under 10 ohms, even at broadcast frequencies. We can call the resistance 10 ohms, in any case, for the purposes of the experiment.

Applying 1 volt at 600 kc., current through the circuit is 0.1 ampere. This current will produce a voltage of 130 across the 1300 ohms of the coil. This voltage can be applied to the grid of a vacuum tube amplifier or detector. We have a resonant circuit, and can readily see why "tuning in" so tremendously increases the strength of a radio signal.

Not only does our coil-condenser combination step up the voltage of the favored frequency—it discriminates vigorously against the other A.C. voltages which may be applied to it. The 200-mfd. condenser has a reactance of only 1100 ohms to 700 kc., while the reactance of the 350 microhenry coil is 1550 ohms.

The total reactance of the circuit is then 450 ohms (1550-1100) and the total impedance so very slightly greater that it is easier to call it 450 ohms and let it go at that. One volt would put a current of a little more than .002 ampere through the circuit at that frequency, and could not build up large voltages across coil or condenser.

Changing either of our reactances will again discriminate against the signal. If

the frequency is maintained at 600 kc., and the condenser capacity is increased from 200 to 300 mfd., its reactance drops to 900 ohms. The circuit now presents a reactance of 400 ohms, enough to discourage all but the most powerful of applied voltages. (It might be interesting to calculate just what frequency the new combination will resonate at.) If at resonance

$$2\pi fL = \frac{1}{2\pi fC}$$

we can work the f over to one side of the equation, and arrive at the conclusion that

$$f = \frac{1}{2\pi \sqrt{LC}}$$

To use microhenries and microfarads, we can use the equation

$$f = \frac{159,000}{\sqrt{LC}}$$

The 159,000 takes care of the 6.28 and the difference between the fundamental units (henries and farads) and the more commonly used units in radio.

The high voltages due to resonance can be put to very practical use. A high-voltage power pack, in which a small power tube, operating at less than 300 plate volts, furnishes 6,000 volts D.C. for a low-current cathode-ray tube supply, has been developed recently. The high-voltage transformer is a simple tuned circuit, and the high-frequency current is rectified through a pair of high-voltage tubes. Sooner or later expensive high-voltage 60-cycle transformers may be a thing of the past, and there is a large and interesting field for experiment along these lines.

When Peace Comes

We will be serving your needs. Amplifier Company of America, as always, is year ahead in Sound Engineering work because of an intense desire to lead the field. Today all of our efforts are on a job that MUST be done, and we are doing that job as ingeniously as expected.

For the time being, please postpone your desires for the finest in amplifiers and special electronic equipment. It's a small sacrifice to ask you to wait until the BIG BATTLE is won.

We are daily helping to solve war problems in the audio-radio-radar-electronic fields. We will gladly collaborate on any unusual problem confronting you. If we can help, and we can help if top-notch engineering is needed, get in touch with us.

AMPLIFIER CO. of AMERICA
17 WEST 20TH STREET NEW YORK N. Y.

**RADIO
AND
ELECTRONIC
DEVICES**



BURSTEIN-APPLEBEE CO.
1012-14 McGee St. Kansas City, Mo.



FREE

SEND TODAY FOR THIS
BIG RADIO BARGAIN
BOOK.



Buy Your
ECHOPHONE
NOW from **LEO**

• Get needed equipment now while still available. We have the best stock on hand, low prices to save you money. Easy terms, quick delivery. Send today for our new catalog of radio bargains. Write to LEO, W9GFQ.

**WHOLESALE
Radio Laboratories**

744 WEST BROADWAY
COUNCIL BLUFFS, IOWA

•LISTENING POST•

FADA

FACTORY SERVICE DEPT.

has replacement parts for all FADA models manufactured during the last 10 years. Call, write, phone or send 10c for our latest Replacement Parts Catalog.

FADA OF NEW YORK

928 Broadway, New York, N. Y.
Gramercy 7-0951

Headset Headquarters



Our Headphones are used by the United States, Canadian, New Zealand and South African Governments as well as other Governments not directly in the war. Folder C-6 illustrates rugged, unusually sensitive, dependable Cannon-Ball Headsets. Write.....

Scientifically Built Heavy ear magnets Greatly increase their efficiency.

C. F. CANNON COMPANY
SPRINGWATER, N. Y.

PATENTS — TRADE MARKS

Booklet concerning Inventions & Patents Form "Evidence of Conception" with instructions for use and "Schedule of Government and Attorneys Fees"—Free

LANCASTER, ALLWINE & ROMMEL
Registered Patent Attorneys
436 Bowen Bldg. Washington, D. C.

THE LISTENING POST

(Continued from page 557)

Mc.	Call	Location and Schedule	Mc.	Call	Location and Schedule
		Latin American beam, 5 to 11:30 pm.	9.690	BBC	LONDON. 10:45 pm to 12:15 am.
11.830	WCRC	BRENTWOOD, NEW YORK. Latin American beam, 7:30 pm to midnight daily.	9.690	LRAI	BUENOS AIRES. Afternoons.
11.830	WCDA	BRENTWOOD, NEW YORK. European beam, 6 am to 6:30 pm daily.	9.680	VLW6	PERTH, AUSTRALIA. 9 am.
11.800	JZJ	TOKYO, JAPAN. 7 to 9:30 pm.	9.670	WNBI	BOUND BROOK, NEW JERSEY. European beam, 2 to 4 am, 5:15 to 7:30 pm. Central American beam; 7:30 pm to 8 am.
11.790	WRUL	BOSTON, MASS. 5:15 pm.	9.650	WGEO	SCHENECTADY, N. Y. Australian beam, 7:15 to 8 am.
11.785	OIX3	LAHTI, FINLAND. 9:15 am.	9.650	WCBX	BRENTWOOD, NEW YORK. Latin American beam, 1 to 11:30 pm.
11.770	DJD	BERLIN, GERMANY. 5:50 pm.	9.640	COX	HAVANA, CUBA. 1 to 11:15 pm.
11.750	BBC	LONDON, ENGLAND. 5:30 to 7:15 pm.	9.635	XGOY	CHUNGKING, CHINA. East Asia beam, 2:30 to 4 pm; European beam, 4 to 5 pm; East Asia beam, 7:35 to 9:55 am; North America beam, 10 to 11:30 am; European beam, 11:35 am to 12:30 pm.
11.720	CJRX	WINNEPEG, CANADA. 12 noon to 1 am; Sundays, 12 noon to 5:30 pm.	9.606	ZRL	CAPE TOWN, SOUTH AFRICA. Daylight transmissions.
11.710	WLWO	MASON, OHIO. European beam, 1:15 to 5:15 pm.	9.595	—	ATHLONE, IRELAND. "Radio Eireann," 7:10 to 8 pm.
11.705	SBP	MOTALA, SWEDEN. 12 to 2:15 pm.	9.590	WLWO	MASON, OHIO. East South American beam, 7 to 12 pm.
11.680	GRG	LONDON. 5:15 pm to 12:45 am.	9.580	GSC	LONDON. North American beam, 5:15 pm to 12:45 am.
11.623	COK	HAVANA, CUBA. 3:30 pm.	9.565	JRAK	TOKYO, JAPAN. 7 to 9:30 pm.
11.150	PRL8	RIO DE JANEIRO, BRAZIL. Afternoons and evenings except Sundays. Off at 11 pm.	9.562	OAX4T	LIMA, PERU. "Radio Nacional" 2 to 8 pm, daily.
10.543	DZD	BERLIN.	9.543	XEFT	MEXICO. Evenings.
10.100	WJQ	Australian beam. 7:15 to 8 am.	9.535	JZI	TOKYO, JAPAN. 8 to 9 am; 2:15 pm; 7 to 9:30 pm.
9.905	WRX	WEST SOUTH AMERICAN beam, 8 pm to midnight.	9.535	SBU	MOTALA, SWEDEN. 12 to 2:15 pm.
9.825	BBC	LONDON. 5:30 pm to 12:45 am.	9.523	ZRH	JOHANNESBURG, SOUTH AFRICA. Daylight transmissions.
9.755	—	DURBAN, SOUTH AFRICA. Day and night transmissions.	9.520	DXL13	BERLIN. North American beam, 5:50 pm.
9.700	WRUW	BOSTON, MASS. 5:15 pm; 7:30 pm to 2 am.	9.505	JLG2	TOKYO, JAPAN. 2:15 pm.
			9.480	WCBX	BRENTWOOD, NEW YORK. Latin American beam, 8 to 11:30 pm.
			8.960	AFHQ	ALGIERS. 6:30 to 7:45 pm.
			8.660	—	West South American beam, 8 to 12 pm.
			8.660	—	West South American beam, 8 pm to 2 am.
			8.035	CNR	MOROCCO, afternoons.
			7.565	WDJ	North Africa beam, 11:45 pm to 2 am.
			7.495	—	CAIRO, EGYPT. 3:15 to 6 pm.
			7.35	WBS	Opens at 1 pm.
			7.290	DJX	BERLIN. Variable times, North American beam; news in English at 7 pm and other times.
			7.171	XGOY	CHUNGKING, CHINA. East Asia beam, 2:30-4 pm; 7:35 to 9:55 am; European beam, 4 to 5 pm; 11:35 am to 12:30 pm; Asia-Australia-New Zealand beam, 6 to 6:30 am; East Russia beam, 6:30 to 7 am; Japan beam, 7 to 7:30 am; North American beam, 10 to 11:30 am.
			7.150	BBC	LONDON. 10:45 pm to midnight.
			7.120	BBC	LONDON. 7:45 pm to 12:45 am.
			7.065	BBC	LONDON. 9:45 pm to midnight.
			6.350	—	Unknown. Heard 9 pm to midnight.

HARRISON HAS IT!

FOR URGENT
WAR WORK—

HALLICRAFTERS

RECEIVERS AND
TRANSMITTERS

TUBES
CONDENSERS
RESISTORS
TRANSFORMERS

AND THOUSANDS OF OTHER
CRITICAL ELECTRONIC PARTS!

PURCHASING AGENTS—

Call upon us for your high priority requirements of equipment and components for your production and development work.

We usually have it in stock!

FOR THE
HOME FRONT—

CODE PRACTICE SET

Buzzer and key, heavily nickel plated, of single-unit construction, mounted on wood base. Adjustable high frequency pitch. Complete with silk covered cord, in attractive box with code chart on cover. Works on one or two flashlight or dry cells.

Postpaid—\$2.45

6L6G First grade, \$1.37 ea.
meter tested, 3 for \$3.75
TUBES fully guaranteed postpaid

DYKANOL CAPACITORS

Cornell-Dubilier oil filled, hermetically sealed metal cased condensers, 4 mfd. capacity. Rated at 220 Volts AC working, will stand over 600 Volts D.C. Ideal for amplifiers, receivers, power packs, etc. (Filtering action equivalent to 12 mfd. electrolytic but with better safety factor, longer life). \$2.25 (3 or more shipped postpaid).

P. M. DYNAMIC SPEAKERS

5 inch, with output transformer to match single plate of 8000 ohms \$1.95
Magnavox, 10 inch, 16 ounce magnet! 6 ohm voice coil \$5.25
(Not Postpaid)

Immediate delivery of the above items, without priority, while quantities last. SEND REMITTANCE WITH ORDER, TODAY! (Money back if not satisfied.)

HARRISON

RADIO CORPORATION

11 WEST BROADWAY

Phone WOrth 2-6276

NEW YORK CITY 7

Mc.	Call	Location and Schedule
6.060	WCDA	BRENTWOOD, NEW YORK. Central American beam, 7:15 pm to 2 am.
6.040	WRUW	SCITUATE, MASS. European beam, 6 to 7 am.
6.007	ZRH	JOHANNESBURG, SOUTH AFRICA. Evening transmissions.
5.85	—	SANTIAGO, D. R. 7:40 pm to midnight.
4.925	HJAP	CARTAGENA, COLOMBIA.
4.905	HJAG	BARRANQUILLA, COLOMBIA.
4.885	HJDP	MEDELLIN, COLOMBIA.
4.865	HJFK	PEREIRA, COLOMBIA.
4.835	HJAD	CARTAGENA, COLOMBIA.
4.785	HJAB	BARRANQUILLA, COLOMBIA.

Mc.	Call	Location and Schedule
6.195	BBC	LONDON. 7:30 pm to 12:45 am.
6.148	ZRD	DURBAN, SOUTH AFRICA. Day and night transmissions.
6.145	HJDE	MEDELLIN, COLOMBIA.
6.120	—	BERLIN. North American beam, variable times.
6.11	GSL	LONDON. American beam, 7:30 pm to 12:45 am.
6.098	ZRK	CAPETOWN, SOUTH AFRICA. Day and night transmissions.
6.095	OAX4H	LIMA, PERU. "Radio Mundial."
6.082	OAX4T	LIMA, PERU. "Radio Nacional."
6.080	WLWO	MASON, OHIO. European beam, 12:15 to 6 am.

— RADIO AMATEURS —

Attention!

WESTERN ELECTRIC CO.

"The Arsenal of Communications"

Offers Positions For:

ELECTRICAL TESTERS

For Radio Transmitters and Receivers. Men who have been licensed radio amateurs preferred, or those having a good technical knowledge of voice communication and trained in electrical testing of radio equipment are needed for inspectors and testers.

Those presently engaged in essential industry will not be considered.

Write (or apply) stating experience and education.

C.A.J., DEPT. 811

Western Electric Co.
100 CENTRAL AVE., KEARNY, N. J.

SIGNAL CORPS WILL BUY YOUR EQUIPMENT

RADIO amateurs are requested to sell their short-wave communications equipment to the Signal Corps, Army Services of Supply. This equipment is needed for training purposes and for operational use.

The equipment needed consists of transmitters, 25 to 450 watt, covering the short-wave and U.H.F. ranges; corresponding receivers; condensers; resistors; power supplies; frequency meters; and installation material.

Especially desired are audio-frequency and radio-frequency signal-generators; oscilloscopes; precision voltmeters, milliammeters and ammeters, both A.C. and D.C. types; and other equipment for testing.

Used equipment will be purchased, if it is in perfect operating order or if it can readily be restored to such condition. The price paid for each item will be set by an inspector of the Signal Corps.

The complete list of the desired equipment is as follows:

Transmitters—(Hallicrafters and Collins) Receivers—(Hallicrafters; National; RME; RCA; Hammarlund; Howard Temco and Collins Model 30 and 32, etc.)

Meters—AC and DC Voltmeters, Ammeters, Milliammeters, R.F. meters and Volt-Ohm-Milliammeters.

Late Model Tube Checkers.

Capacitors—Mica and paper types.

Oscilloscopes, 2 and 3-inch.

Audio Signal-Generators.
R.F. Signal-Generators.

Photographic: 35 MM Motion Picture Cameras, such as Mitchell (all models), Bell & Howell—Standard Professional, Akeley-Professional (all models) and Eyemo (all models) Bell & Howell Mfg. etc. and 16 MM Motion Picture Cameras (such as Cine-Kodak Special, Magazine Cine-Kodak Filmo 70.D or Filmo Auto Master); Tripods; Lenses, all types for 35 mm and 16mm equipment, Exposure Meters; and Cameras (such as Speed Graphic 4" x 5", and Speed Graphic 2 1/4" x 3 1/4" with or without flash synchronizers) and Leica Model III (F) or 11B (G), or equal; Range Finders; Pack Adaptors and Cut Film Holders.

Price consideration is based upon your net cost less reasonable depreciation for use, age and condition of equipment. Inasmuch as all equipment is being purchased F.O.B. Philadelphia, cost of packing and shipping can be shown separately so that an allowance for the costs can be made when material is accepted.

Persons in possession of the desired equipment who wish to sell it for the use of the Army, are invited to send a brief description, including the name of the manufacturer, and the model type, to Captain James C. Short, Philadelphia Signal Corps Procurement District, 5000 Wissahickon Avenue, Philadelphia, Pa.

FUTURE OF TELEVISION

IF television did nothing more before the war than train engineers in the art of high frequency work, it was well worth while, for this knowledge has been extremely important to the Allies in the war now being fought, according to Dr. W. R. G. Baker, General Electric vice president.

High frequencies never before available to the television engineer have been brought into use as a result of war research, he said, comparing the pre-war television frequency band with a small boat. "Let us imagine this small boat as the only means of contact between two countries on opposite sides of a river, and the amount of trade and intelligence passing between the countries being limited by the boat's capacity. War research has broadened the usable television frequency band just as a bridge built across the river between the countries would provide greater capacity for traffic between these countries."

The television sets built after the war probably will produce pictures in black and white because color television may be too

expensive and still has not been worked out to the engineer's satisfaction. Color television will come, but probably not for some time after the war ends.

Post-war relaying of programs will be done with coaxial cables or television relay stations, or possibly a combination of both. Television is essentially a line-of-sight operation from transmitter to receiver. Stations will therefore probably be located in the larger cities, with transmitters located where they can reach the most receivers.

The size of the picture produced by a television set will depend on public demands. The average person probably will want a picture from 12 to 15 inches square so that he can sit seven or eight feet away from the television set and enjoy the program.

There is no technical reason why motion picture houses cannot receive and project special television pictures on their screens after the war if such a procedure can be made economically sound and if managers can attract audiences to the theaters to see these pictures, Dr. Baker said.

ELECTRONICS

Engineers
Laboratory Assistants
Production Men

Well Paying War Job Plus Peace Time Career!

Ideal working conditions with expanding manufacturers now at war work and planning peace time developments. Unlimited opportunity for an important place in a New World of Radio.

Men employed at full skill in war industry should not apply!

All others write Today!

PANORAMIC RADIO CORP.
242 West 55th Street
New York New York

OPPORTUNITY AD-LETS

Advertisements in this section cost 20 cents a word for each insertion. Name, address and initials must be included at the above rate. Cash should accompany all classified advertisements unless placed by an accredited advertising agency. No advertisement for less than ten words accepted. Ten percent discount six issues, twenty percent for twelve issues. Objectionable or misleading advertisements not accepted. Advertisements for July, 1943, issue must reach us not later than June 15, 1943.

Radio-Craft • 25 W. B'way • New York, N. Y.

RADIO SERVICEMEN AND EXPERIMENTERS SEND for our giant radio catalogue. Save dollars. United Radio Co., (1000?) Newark, N. J.

SONG POEMS WANTED TO BE SET TO MUSIC. SEND poem for immediate consideration. Five Star Music Masters, 415 Beacon Bldg., Boston, Mass.

USED Correspondence Courses

COMPLETE HOME-STUDY COURSES and self-instruction books, strictly used. Sold, rented, exchanged. All subjects. Satisfaction guaranteed. Cash paid for used courses. Full details and 84-page illustrated bargain catalog FREE. Write today!

NELSON COMPANY, 321 S. Wabash, Dept. 210, Chicago

PHONES AND SPEAKERS; HOW DO THEY WORK?

(Continued from page 547)

it is necessary to cover a loud area efficiently. Horns are used almost exclusively in moving-picture theatres, meeting halls and large outdoor installations such as athletic fields.

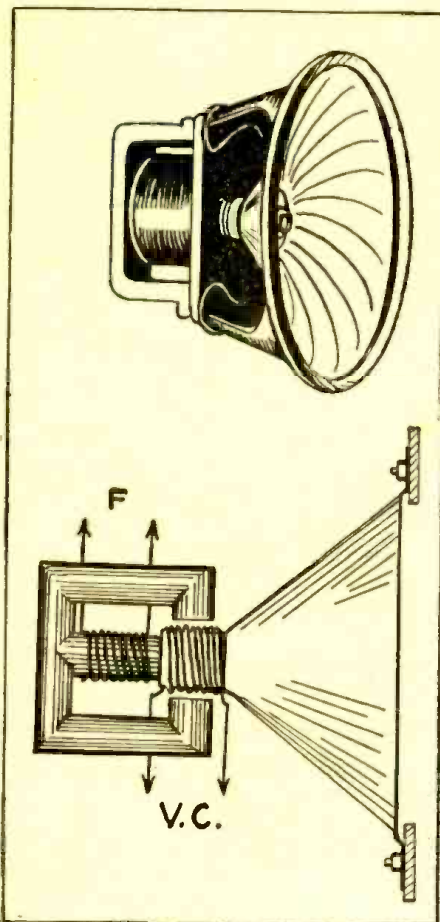

Fig. 4. A typical dynamic speaker is shown at the top. The position—but by no means the comparative size—of the field and voice coils is illustrated at bottom.

THE BALANCED ARMATURE

The diaphragm had many limitations. Strong currents through the coils caused it to strike the magnets, causing "chatter." If it were made stiff enough to prevent this, it would not respond properly to weaker signals or to certain frequencies. This resulted in distorted reproduction.

The next step in the evolution of the telephone receiver was the "balanced armature" unit which corrected many of these shortcomings.

This type of receiver is shown in Fig. 3. Instead of a diaphragm against the magnet, we have a flat armature A. The magnet or magnets are provided with pole pieces which approach A closely on each side. The poles are as shown in the diagram. The wire coil which was wound around the pole pieces in the older type of telephone is now wound on a spool inside of which the soft-iron armature is pivoted.

The armature has no polarity till current flows in coil C. Let us suppose that this current is in such a direction as to make the right end of A and N pole and the left, an S pole. The armature will be attracted toward the right S pole and be repelled from the N pole. The left end will be attracted toward the N and repelled from the S of the permanent magnet. As a

result, the right end of A moves down and the left moves up. A metal stylus S, attached to the end of A, moves the diaphragm accordingly.

The diaphragm may be of light material, such as aluminum or mica, better able to follow the music than the stiff iron one formerly used. By using a very large paper diaphragm, big enough in itself to couple directly to the air in the room, it became possible to eliminate the horn. The new cone speakers varied from a little less than a foot to about three feet in diameter, and gave much better results than the horn speakers previously used.

The horn, for all its efficiency, has many disadvantages in small receivers. To properly reproduce low notes, it should be at least seven feet long! The small horns used with home receivers could not meet the cone on the ground of quality, with the result that they were soon displaced.

THE MOVING-COIL SPEAKER

Radio receivers continued to become more powerful and listeners more critical, and even the new magnetic cone was found unsatisfactory. The new power tubes made it chatter like the old metal diaphragm. One of the oldest types of speaker—many years dormant because of its greedy consumption of "A" battery current—again came to the front.

This was the *dynamic speaker*. The principle on which this works is shown in Fig. 4. A large magnet, in the shape of a "pot" with a round central core, is magnetized by a spool of wire which completely fills it. The core forms one pole of the magnet and the "pot" the other. A cover on the "pot" has a round hole in it for the central core, leaving just a narrow gap between the two. This narrow gap is the space between the two poles, and because of its small extent as well as its

shape, the magnetic field in the gap is very strong.

A small coil of wire, wound on a light cylinder of paper or thin fiber, is suspended in the magnetic gap. This *voice coil* carries the signal currents. The coil is attached to the paper cone (or in the case of the original dynamic, to the aluminum diaphragm), of the speaker.

The principle of operation is simple. Assume that the pot is so magnetized that the top of the center core is an N pole, and that the current flowing through the voice coil is such that the bottom of it is an S pole. The magnetic field around the coil is in a direction that causes it to be drawn down. With a reversal of the signal current, the bottom of the voice coil becomes an N pole and is repelled or pushed upward. It can be seen that the coil will move according to the variations in current through it, which are in turn controlled by the variations in speech or music at the distant transmitter.

No matter how strong the signal impulses, this speaker cannot chatter. The voice coil moves parallel to the center magnet and remains at a constant distance from it at all times. The cone or diaphragm is freer to move in this than in any other type of speaker. Hence it can follow the variations in signal current more closely, with a consequent improvement of quality in the reproduction of speech or music. The stiff diaphragm of the old telephone unit, and the stiff springs of the balanced-armature speaker prevented them from reproducing with the utmost fidelity. The cone of the dynamic speaker—suspended by a light leather ring around the edge—is practically free to "follow the music" and does so, with a tremendous improvement in quality over the older types of speakers.

WHAT YOU SHOULD KNOW ABOUT ELECTRONICS

(Continued from page 546)

slow compared with the time required for them to move from one electrode to another.

The second reason that electron tubes are unique is their ability to control electrical currents smoothly. Most devices that are used to vary an electric current do it step-by-step. The charge carried by each electron is so exceedingly small that the rhythmic increases and decreases of current to reproduce music or the human voice are easily, accurately, and smoothly accomplished.

The third feature is their ability to control the movement and velocity of the speeding electrons by merely changing the electrical potential of one of the electrodes inside the tube. This requires only a very small amount of electrical power. (This is just another way of expressing the well-known fact that electron tubes are amplifiers and can reproduce, at a greatly increased power level, the impulses fed to them.)

The fourth feature is their ability to pass current only in one direction or, as it is often expressed, to act as rectifiers.

If one considers electron tubes in the light of these four unique characteristics, it is readily seen why they are so essential to modern radio. It is because these tubes possess and can utilize simultaneously some or all of these properties. In turn, modern radio needs just these properties. It is easy to understand this when we re-



This reproduced music of "excellent quality and great volume" (1923 advertisement), with a pair of headphones clamped to its base.

member that radio is inherently a science of very high electrical frequencies; that it requires complicated wave forms, and that at the receiver one must pick up the very minute amount of power received from space by a few inches of wire and increase it to a point where the reproduced sound is at a relatively high power level or, as we say, has been greatly amplified.

Electron tubes are now available in an almost bewildering array of kinds and sizes and are now in use for many purposes in addition to radio. However, in all their applications, they represent that vital link in the electrical circuit where the current flowing in that circuit is no longer in a wire but rather of such a nature that it can be controlled in unique and useful ways "free from the bondage of wires." Such is the essence of electronics.

VOLUME EXPANDER

(Continued from page 548)

amplifier, and being variable mu, allows a wide range of amplification without distortion. A 6B8 tube is used as an amplifier to feed the 86M, the latter connected up as a rectifier. (A 6C5 or a 6H6 can be used in place of the 86M.)

OPERATION

The main volume control R1 is adjusted to give slightly more than normal room volume with control R3 turned to half way position and R2 turned off. Next, turn R3 to bring volume down to normal. This increases the bias on the 6SK7 and reduces the amplification of this stage. Control 2 actually controls the amount of expansion. Expansion increases as R2 is turned farther from the "off" position. Once a suitable amount of expansion is reached, it is not necessary to adjust controls R2 or R3 any further. R1 will control the total volume and automatically adjust the expansion, volume and expansion increasing simultaneously. Switch S1 cuts the expander in or out of circuit. With S1 closed, there is no expander action, and the system works as an ordinary amplifier.

EXPLANATION OF ACTION

The expander action is as follows. With no signal applied to the grid of the 6SK7, R3 is adjusted so that there is no bias on the 86M cathode, with S1 open and R2 turned off. Then R1 is opened, feeding a signal through the amplifier. It will be found that making the 86M cathode negative, by turning R3, that the volume will be reduced, as the voltage is also applied to the 6SK7 grid through the filter network of chokes and condensers. This network controls the time constant of the expander, in this particular case giving 1/15 second lag in voltage fed to the 6SK7.

As R2 is opened, feeding signal to the 6B8 and through to the 86M a positive voltage appears at the 86M cathode due to the rectifier action of this tube. As much as 20 volts positive can be developed in this way by heavy signals and applied to the 6SK7 grid, bucking the original negative voltage, thus increasing the amplification of this stage enormously, and constituting the expander action.

The following stages of the amplifier are not shown, but in the original consisted of a 6C5 fed into push-pull Class A 6L6's, fairly large power outputs are necessary to duplicate the volume range of an orchestra.

COMPRESSION

This same circuit can be used as a compressor by using a D.P.-D.T. switch to reverse the connections to the 86M tube.

LEARN CODE the way you'll be using it by **SOUND**



The best way to learn to read code is by listening to code. The best way to learn to send code is by hearing your own sending repeated back to you. With the new All-Electric Master Teleplex Code Teaching Machine, you learn code the natural, easy, fascinating way. Only instrument ever produced which records your sending in visible dots and dashes—then SENDS BACK your own key work at any speed you desire. There are NO PERFORATIONS—NO INK. Far superior to anything ever developed... a marvel of simplicity. That's why practically every school teaching code uses TELEPLEX. We furnish complete course, including the All-Electric Master Teleplex, give you personal instruction with a MONEY BACK GUARANTEE—all at a surprisingly low cost. Write today for FREE catalog S6. No obligations.

TELEPLEX CO., 107 HUDSON ST. JERSEY CITY, N. J.



HIGH EFFICIENCY results in *Sound National Defense* that is why **NATIONAL DEFENSE SOUND SYSTEMS** are equipped with *University Reflex* **HIGH POWER LOUDSPEAKERS** **UNIVERSITY LABS.** 225 VARICK ST. N.Y.C.

Inventions Wanted Patented or Unpatented

We have been successfully selling inventions, patented and unpatented, since 1924. Write us, if you have a practical, useful idea for sale. **CHARTERED INSTITUTE OF AMERICAN INVENTORS** Dept. 109, 631 Pa. Ave., N.W., Washington, D.C.

SUBSCRIBE NOW TO—

AND RECEIVE FREE THIS DICTIONARY



FULL LIBRARY SIZE WEBSTER DICTIONARY 378 PAGES

FIVE MONTHS \$1.00
TWELVE MONTHS \$2.50

SPECIAL NOTICE TO OUR READERS

Due to wartime curtailment of paper, we are unable to meet the increasing newsstand demand for RADIO-CRAFT. We are therefore making this special introductory offer to our readers. Assure yourself of getting a copy of RADIO-CRAFT monthly by subscribing now and at the same time co-operate in making this wartime measure effective. Don't delay—Send in your order today. Take advantage of our special long-term offer and protect yourself against any possible increase in price by sending \$2.00 for 12 issues.

If you will take advantage NOW of our special subscription offer of five months for \$1.00 or twelve months for \$2.00, we will send you ABSOLUTELY FREE and POSTPAID this 378-page WEBSTER'S PRACTICAL ILLUSTRATED DICTIONARY—useful and instructive to all. This self-pronouncing authoritative dictionary—a brand new work throughout—contains the most up-to-date words now in common use. Over 20,000 definitions in all. In addition, it has the following: List of Largest Cities in the U. S.; List of Principal Cities of the U. S.; List of Principal Cities of Canada; National Parks of the U. S.; Time and its Variations; Tables of Weights and Measures; Presidents of the U. S.; Synonyms and Antonyms; Dictionary of Commerce and Law; Dictionary of Forms of Address; Military and Naval Information (illustrated); Digest of the Purposes of Current Federal Agencies.

THIS IS A TIME LIMITED OFFER

MAIL COUPON TODAY FOR A

SUBSCRIPTION AND DICTIONARY

RADIO-CRAFT
25 WEST BROADWAY
NEW YORK, N. Y.



RADIO-CRAFT, DEPT. 643, 25 WEST BROADWAY, NEW YORK, N. Y.

Gentlemen: Enclosed you will find my remittance for which enter my subscription to RADIO-CRAFT Magazine for the period checked below. Send me ABSOLUTELY FREE and POSTPAID the book I have checked.

5 months — \$1.00 12 months — \$2.00

This is a new order Renewal

NAME
Please Print Clearly

ADDRESS

CITY STATE

Remit by check or money order; register letter if you send cash or unused U. S. Postage Stamps. (Canadian orders must be accompanied by an International Money Order.)

EXPERIMENTERS

The war has made a terrific inroad in practically all electrical and mechanical supplies. We are fortunate in being able to offer difficult to obtain merchandise listed below. As supplies are limited, we suggest that you order immediately before certain of the items are sold out. All of the attractive items listed here are brand new, except where indicated. ALL are in PERFECT WORKING ORDER. In many cases, the parts alone total more than the price we are asking. Satisfaction guaranteed or your money back. ORDER FROM THIS PAGE. Use our convenient coupon. Include sufficient extra remittance for parcel post charges, otherwise order is sent express collect. Any excess will be refunded. All C.O.D. shipments require 20% deposit. NO C.O.D. shipments on orders for less than \$3.00. If full remittance accompanies order, deduct 2% discount. Send money order, certified check, or New U. S. stamps. No C. O. D.'s to foreign countries.

ORDER TODAY LIMITED QUANTITIES PROMPT SHIPMENTS ASSURED

THE SODERWAND SUPER SOLDERING IRON

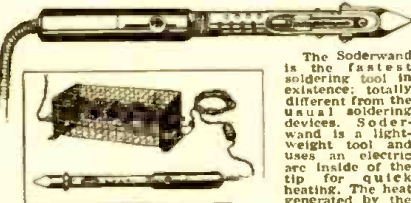

The Soderwand is the fastest soldering tool in existence; totally different from the usual soldering devices. Soderwand is a light-weight tool and uses an electric arc inside of the tip for quick heating. The heat generated by the arc is so intense that within 60 seconds after starting, the copper is hot enough to flow solder. There is a constant surplus of heat which makes quick soldering jobs seem easy. Current consumption is small, as only intermittent current is necessary to keep iron hot. Convenient thumb control cuts current on or off. Simple in design. Burn-out impossible as there is no heating element to burn out.

The Soderwand is an all-purpose tool that takes care of the heaviest or most delicate job with equal ease. IMPORTANT: This is a brand new item and comes in its original packing. We acquired the manufacturer's entire stock, which is the reason why we can sell the tool for so little money. THE ORIGINAL PRICE WAS \$5.00.

Supplied with regular No. 5 pronged tips, 14 feet of cord, attachments, plugs, resistance unit, and two extra sets of carbons. Made for 110 volts A.C. 60 cycles, or D.C. Size: 13" long. Tool weighs 10 oz. Ship. wt. of outfit 4 lbs. ITEM NO. 154 YOUR PRICE \$3.95

WATCH-CASE MICROPHONE

This mike contains a unit like the famous Skinderviken Button, mounted in a cast-aluminum case resembling a large headphone unit. 2-inch diaphragm. A push-to-talk switch is mounted in the case. 200-ohm impedance. Works into any transformer designed for single-button microphones. Operates on one dry cell. Just the thing for home telephone sets, "home broadcasting," use with phonograph oscillators, etc. Case finished in black enamel. Slightly used. Size 2 3/4" by 1 1/2". Shipped postpaid. ITEM NO. 156 YOUR PRICE \$1.00



SENSITIVE RELAY

This relay has back and front contacts and makes another when actuated. 5-ohm coils, sterling silver contacts, 5 binding posts. Relay can be adjusted to trip at 50 milliamperes. Invaluable to experimenters. Can be used for remote control of apparatus, as circuit-breaker, etc. Will operate as electronic relay in plate circuit of average power tubes, as in air-rated "valve" units and other automatic devices. Adjustable hair-spring tension. Heavy slate-and-iron base 3 3/4" by 3 1/4". All metal parts (except base) in heavy brass. Slightly used, but a first-class relay in all respects. Ship. Wt. 3 lbs. ITEM NO. 155 YOUR PRICE \$1.85

POWERFUL ALL-PURPOSE INDUCTION MOTOR IDEAL FOR EXPERIMENTERS—101 USES

Sturdily constructed to precision standards, this self-starting shaded pole A.C. induction motor is powerful enough for a large variety of uses. Some of these are: Automatic Timing Devices, Current Interrupters, Electric Fans, Electric Chimes, Window Displays, Photocell Control Devices, Electric Winchors, Small Grinders, Buffers and Polishers, Miniature Pumps, Mechanical Models, Sirens, and other applications.

Consumes about 15 watts of power and has a speed of 3,000 r.p.m. When geared down, this sturdy unit will constantly operate an 18-inch turntable loaded with 200 lbs. dead weight—THAT'S POWER! Dimensions, 3" high by 2" wide by 1 3/4" deep; has 4 convenient mounting studs; shaft is 3/16" long by 3/16" diameter, and runs in self-aligning oil-retaining bearings. Designed for 110-20 volts, 50-60 cycles, A.C. only. ITEM NO. 147 YOUR PRICE \$1.95

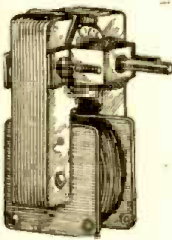

WESTERN ELECTRIC BREAST MIKE

This is a fine light-weight alnico carbon microphone. It weighs only 1 lb.

Mike comes with breast-plate mounting and has 2-way swiveling adjustment so that it can be adjusted to any desired position. There are 2 woven straps, one goes around neck, the other around chest. Straps can be snapped on and off quickly by an ingenious arrangement.

This excellent mike can be adapted for home broadcasting or private communication systems. By dismounting breastplate, it can be used as desk mike. Comes complete with 6-foot cord and hard rubber plug. Finished in shoradized plate, non-rustable.

THIS IS A BRAND NEW MIKE. IT HAS NEVER BEEN SOLD AT SUCH A LOW PRICE BEFORE. ORIGINAL LIST PRICE \$15.00. Shipping weight, 2 lbs. ITEM NO. 152 YOUR PRICE \$2.55

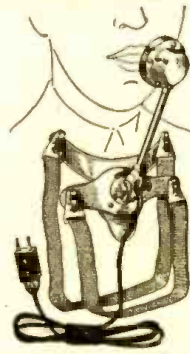

VARIABLE SPEED UNIVERSAL MOTOR

For 110 Volts, A.C. or D.C. All Nickel Plate

Edison Dictaphone motor 1/50 H. P. Used but in excellent condition. For buffing, polishing, drilling, sawing, runs phonographs, fans, models, blowers, lathes, etc. Special control permits variable speeds up to 1500 r.p.m. 5/16" shaft extends from both sides of motor. Cast iron base has 3 screw mounting holes. Height 4 1/2", length 7 1/2", width 5 1/2". Shaft is 1 3/4" diameter. Ship. Wt. 8 lbs. ITEM NO. 157 YOUR PRICE \$2.95

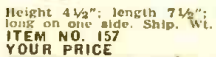

POWER ADJUSTABLE RHEOSTAT

Here is an excellent rheostat used especially to regulate speeds of small motors, such as our Handy Workshop Outfit. This rheostat can be used in connection with motors up to 1/20 h.p. This fine rheostat is wire-wound on porcelain insulation. The black enamel steel casing is perforated for ventilation. Adjustable handle regulates speed of motor easily and smoothly. Size 5" x 2 3/4" overall. Ship. Wt. 2 lbs. ITEM NO. 153 YOUR PRICE \$1.45

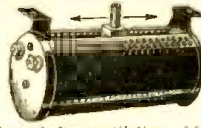

AMAZING BLACK LIGHT!!

Powerful 250-Watt Ultra-Violet Source

The best and most practical source of ultra-violet light for general experimental and entertainment use. Makes all fluorescent substances brilliantly luminescent. No transformers of any kind needed. Fits any standard lamp socket. Made with special filter glass permitting only ultra-violet rays to come through. Brings out beautiful opalescent hues in various types of materials. Swell for amateur Wayne makes, etc. to obtain unique lighting effects. Bulb only. Ship. Wt. 1 lb. ITEM NO. 87 YOUR PRICE \$2.45



WATTHOUR METER

Completely overhauled and ready for immediate service. For regular 110-volt, 60 cycle 2-wire A.C. circuit. Servicemen use it in their shops to check current consumption of sets, soldering irons, etc. Keeps counts down. If dismantled, the parts alone would bring the price. The elaborate train cover can be used as a counter on machines of various kinds. Simple to install: 2 wires from the line and 2 wires to the load. Sturdily constructed in heavy metal case. 8 1/2" high, 6 1/4" wide, 7" deep. Westinghouse, G. E. or Ft. Wayne makes. Ship. Wt. 14 lbs. ITEM NO. 33 YOUR PRICE \$4.95

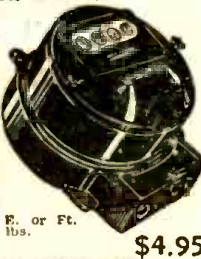

"ROCK OF AGES" SOLDERING IRON

By RALPH W. MARTIN

FEW radio bench workers know what a real soldering iron holder looks like—so here it is:

This is a photo of the one which the writer has used for several years, and found to be the real thing.

It is cut from granite and measures 6 x 6 x 10 inches. It is quite massive and heavy, but these qualities are a decided advantage, for they make the holder always easy to locate, and because of its weight it will usually always be found in the same place. These desirable features are not possessed by those profanity-provoking little thingamajigs usually used as iron holders.

In addition, such a holder as above prevents the escape of much of the heat into the surrounding air. A large amount of the heat becomes stored up in the rock, and is then radiated back to the iron, thus causing the iron to become superheated and making it a quicker melter. Same principle as regeneration.

This storing of the heat is bound to result in the delivery of more heat units per watt of line power used.

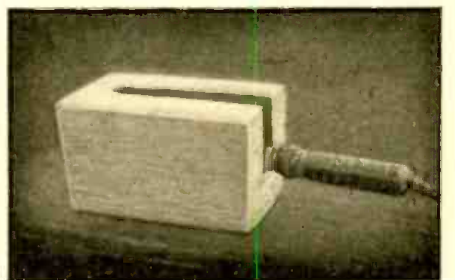

The outside should be painted white, while the slot should be black. This causes the block to radiate less heat into the air and more onto the iron.

The one shown in the photo is covered with asbestos paper as a means of further preventing external radiation and conserving more heat.

Probably the best holder would be one made of fire clay and covered with a thick coating of asbestos.

FREAKISH FM

FM RADIO owners who have been informed that their sets will receive only from the local station or stations, are sometimes agreeably surprised to hear from points hundreds of miles away. One doctor in Florida even receives the baseball broadcasts from W43B in Boston regularly.

Reports come in from owners of FM receivers in places not served by regular FM broadcast stations. Reception from distances of more than 1,000 miles is occasionally reported. One of the more interesting ones was from a fan in Timmins, northern Ontario, who verified reception from W49FW at Fort Wayne, Indiana.

A set-owner in the Pennsylvania mountains received so many distant stations that General Electric engineers are studying the district.

These cases are examples of what the amateurs who worked on 5 meters call "sporadic break-through" and depend on abnormal magnetic or temperature conditions. They must be classed as "exceptions that prove the rule"—the rule that radio can always be depended on to turn up the unexpected now and then.

HUDSON SPECIALTIES CO., 40 West Broadway, N. Y. C.

IT'S EASY TO ORDER—CLIP COUPON—MAIL NOW ORDER FROM THIS PAGE.

HUDSON SPECIALTIES CO., 40 West Broadway, Dept. RC-6-43, New York, N. Y.

I have circled below the numbers of the items I'm ordering. My full remittance of \$..... (include shipping charges) is enclosed. NO C.O.D. ORDERS UNLESS ACCOMPANIED WITH A DEPOSIT.

OR my deposit of \$..... is enclosed (20% required), ship order C.O.D. for balance. NO C.O.D. ORDER FOR LESS THAN \$3.00. (New U. S. stamps, check or money order accepted.)

Circle Item No. wanted: 33 87 147 152 153 154 155 156 157

Name Address

Please Print Clearly

City State

Send remittance by check, stamps or money order; register letter if you send cash or stamps.

NEW RADIO-CRAFT LIBRARY BOOKS

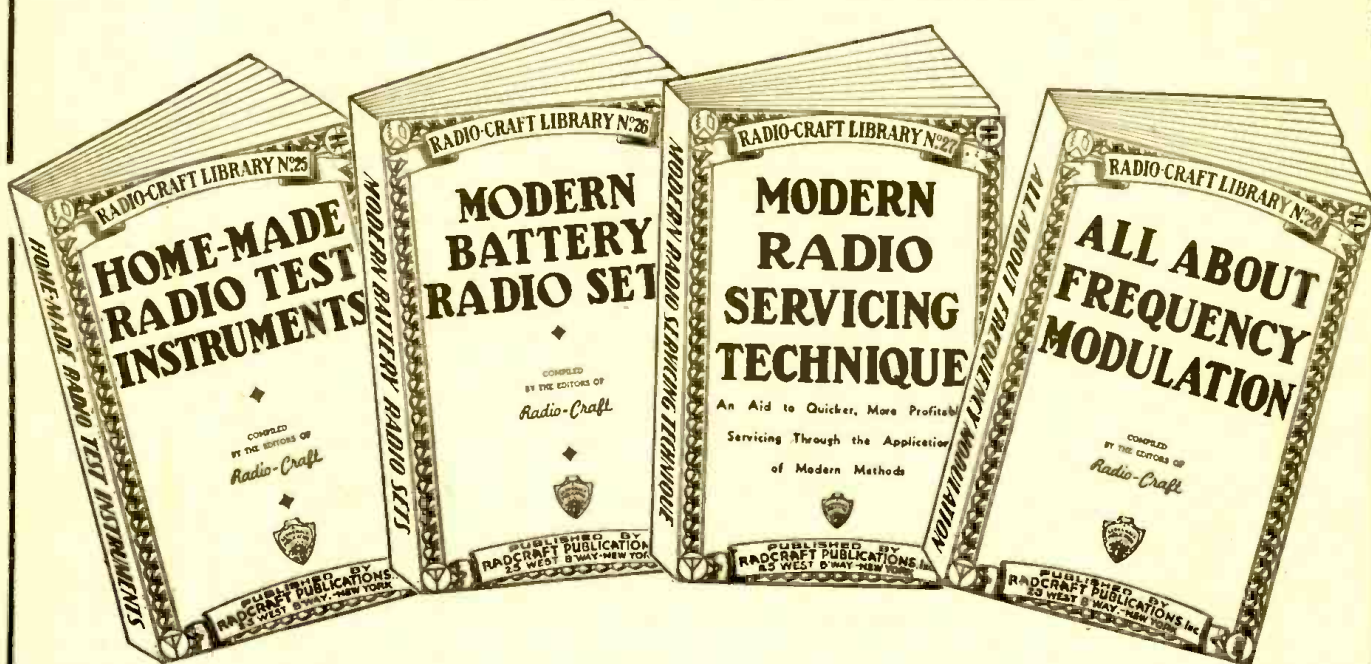

THIS four latest books of our well-known RADIO-CRAFT Red Books—Nos. 25, 26, 27 and 28—recently published. These four books are all on timely subjects and we recommend every one of them to you strongly.

Now, more than ever, radio education has become a burning question. If you are to be in the National Service, in the Army, Navy or Air Force—practical radio knowledge is of paramount importance. **YOU CAN GET BETTER RATINGS AND ADVANCE QUICKER IF YOU HAVE A GOOD RADIO BACKGROUND.**

Conversely, if you are not with the armed forces, there is a whole of a job to be done at home. With more and more men going into the service, the demand for practical servicemen becomes greater each day. Therefore we say: **PROFIT BY THESE UNIQUE BOOKS, WHICH ARE PRICED SO LOW THAT THEY ARE WITHIN THE REACH OF EVERYONE'S PURSE.**

No. 25—HOME-MADE RADIO TEST INSTRUMENTS

This book includes articles covering a wide range of test apparatus of live interest to every radio man. Servicemen will find many circuits in this book to make their work more profitable. New ideas in test equipment make it possible to service radio receivers more quickly.

Laboratory workers and experimenters will find many articles which describe in detail construction and use of all essential radio test units—multi-meters, oscillators, stage-analysis testers, oscilloscope equipment, V.-T. voltmeters, etc. Even advanced technicians will be interested in the circuit arrangements showing the new and improved variations of well-known, basic test equipment. A MUST for every serviceman. This book contains 86 illustrations.

Outline of Contents: A Low-Cost Signal Chaser—Signal Tracer Test Unit—Simplified Practical Signal Tracer—A Home-Made Infinite-Resistance Tube Checker—Build This Direct-Reading V.-T. Voltmeter—How to Make a Modern V.-T. Voltmeter—Measuring High Values of A.C. Voltage and Current With a Low-Range Meter—How to Make a Meter-Range Extender—How to Build a Practical Tube Tester and Set-Analyzer Adapter—The Beginners' Simple Volt-Milliammeter—Build This Simplified Neon-Type Test Unit—Midwest Oscilloscope—How to Make and Use a Frequency Wobbler—Double Tracing Your Oscilloscope—Home-Made Frequency Modulator.

No. 26—MODERN BATTERY RADIO SETS

Whether you are a radio man or a beginner, the articles in this book give you basic circuit arrangements or elementary radio receivers which serve the dual role of teaching the elements of radio reception, as well as making perfectly operating 1- and 2-tube radio receivers. Picture diagrams and bread-board layouts galore.

Advanced radio set builders are offered more complicated arrangements. Laboratory workers and engineers will find in many of the articles circuit and constructional features which have become commercial practice. Many entirely new ideas are given in this book. One of the most important volumes we recently issued. This book contains 76 illustrations.

Outline of Contents: Beginner's 1-Tube High-Gain All-Wave Receiver—Beginners-Build This 1-Tube Loop Receiver—A "3-in-1" Battery Portable—An Easily-Built "Flewoiling Superregenerative" 2-in-1 "Card File" Battery Set—A 2-Tube Superhet. With Pentagrid Regenerative 2nd-Detector—The 4-Tube Superhet. Vacation Portable—The "Lunchbox 5" Battery Portable—The "Seafarer" Loop-Type Boat Radio Set—4-Tube Permeability Portable—An All-Purpose Portable—A Typical Commercial 3-Way Portable (Pilot Models X-1452 and X-1453)—Switch for Varying "C" Bias on Battery Radio Sets—Making a Simple Portable Aerial—Making a Pilot-Light Fuse—Old Auto Sets for New Cars—Using a Loop Portable in Cars—Quasi-Electric Soldering Iron—Lamp Bulbs as Resistors.

No. 27—MODERN RADIO SERVICING TECHNIQUE

Here is a book of great importance to every radio man, every radio engineer, and particularly all radio servicemen. A list of the contents which follows shows the importance of this book. Literally jam-packed to overflowing with radio-meat. Whether you are a servicing beginner or whether you are an experienced serviceman—you will find many important helps in this volume.

Book is eminently practical and will solve many problems for you. More important: It will show you many short-cuts, all calculated to save your time and patience. Practical everyday data on standard receivers appears throughout the book. A whole of a book compressed into a minimum of space. Contains 98 important illustrations.

Outline of Contents: Elementary Servicing Technique—Correct Procedure for the Servicing Beginner—Elementary Procedure for Servicing Radio Sets—A.F.C. Alignment Made Easy—Dynamic Servicing—Dynamic Testing Simplifies Servicing—Modern Receiver Test Requirements—Servicing Universal A.C.-D.C. Receivers—Servicing "Orphans" and Private-Brand Sets—Emergency Servicing Without Test Meters—Servicing Coils—Servicing R.F. Coils—Servicing Oscillator Coils—General Information—RWA Transformer Color Code—What Causes Echo, Fading?—Radio Service Puzzlers.

No. 28—ALL ABOUT FREQUENCY MODULATION

Here is a complete compilation of pertinent data on the entire subject of the new coming art of Frequency Modulation.

There is no question but that Frequency Modulation is already revolutionizing radio broadcasting in this country. Were it not for the war, there would now be a tremendous boom in this new art—yet, even with war restrictions imposed upon it, Frequency Modulation is still jumping ahead by leaps and bounds.

With Frequency Modulation no longer a theory—with hundreds of stations already dotting the land and with countless hundreds of others to come when peace is achieved once more—every radio man should read up and know all there is to know on this most important subject.

This particular handbook is chock-full with a tremendous amount of information which you probably will not find in any similar book in print.

Outline of Contents: The ABC of F.M.—Frequency vs. Amplitude Modulation—Basic Facts About F.M. Broadcasting—Construction—Build This Practical F.M. Adapter—Audio Amplification—F.M. Audio Amplifier, Part 1—F.M. Audio Amplifier, Part 2—F.M. Audio Amplifier, Part 3—F.M. Service—Part 1, Antenna Installation and Service—Part 2, Receiver Alignment and Diagnosis—Part 3, Test Equipment for F.M. Servicing, Engineering—Part 1, The How and Why of F.M.—Part 2, The How and Why of F.M.—Theory and Design Considerations of R.F. and I.F. Coils in F.M. Receivers.

SPECIAL SEND-NO-MONEY OFFER

It is not necessary that you send money with order. If you wish to take advantage of our C.O.D. Plan, simply cut out the coupon, paste it on a post card and send it to us. Books will be sent to you immediately.

All four books are listed uniformly at 50c each. No discount on less than three books.

If you wish to take advantage of our special offer, ordering three books or more, we make an unusual low price to you as follows:

3 books—\$1.25
4 books—\$1.50

Do not fail to send coupon today!

RADCRAFT PUBLICATIONS, INC.
25 West Broadway, New York, N. Y.

RADCRAFT PUBLICATIONS, INC.		643
25 West Broadway, New York, N. Y.		
Gentlemen:		
Rush to me by return mail, as per your special offer, the following books: (Check books selected.)		
<input type="checkbox"/>	No. 25—HOME-MADE RADIO TEST INSTRUMENTS.	
<input type="checkbox"/>	No. 26—MODERN BATTERY RADIO SETS.	
<input type="checkbox"/>	No. 27—MODERN RADIO SERVICING TECHNIQUE.	
<input type="checkbox"/>	No. 28—ALL ABOUT FREQUENCY MODULATION.	
I will pay postman \$1.00 (if two books are ordered) plus a few cents postage and charges. \$1.25 for three books, plus a few cents postage and charges. \$1.50 for four books, plus a few cents postage and charges.		
WE CANNOT SEND A SINGLE 50c BOOK C.O.D.		
NAME		
PLEASE PRINT CLEARLY		
ADDRESS		
CITY		STATE
<input type="checkbox"/> Save shipping and C.O.D. charges! Check here if you send cash with order. (Cash, U.S. new postage stamps, money order, check.) Foreign countries no C.O.D. Add 20% to all prices quoted.		

SIX-TUBE BROADCAST RECEIVER

(Continued from page 544)

- 1 6U5 socket assembly
- 5 6eta sockets
- 8/32 machine screws and nut and hook-up wire, etc.

The shaft used for tuning was made from an old volume control, the control was broken up so that only the shaft and center bushing were left. A file was used to make a shallow groove about 1/2" wide in the shaft close to the bushing and the cable runs in this groove.

The groove must be shallow and rounded, or the cord will wear out very quickly. If slippage occurs, use a "belt dressing" made by melting resin in vaseline or transformer oil. A little of this applied to the dial cord will make it cling tighter than a tube shield in a midget portable. Dial cable should be of the best fishline, of course—it is much better than some of the "dial cord" being sold nowadays.

A small coil spring is used to keep the correct tension on the cable, and if the pulleys are all lined up, you should have a job as good as the commercial one, with the additional advantage that you can put your own lettering on the glass dial plate.

CHEMISTRY NOW SPEEDED WITH AID OF ELECTRONS

(Continued from page 527)

dustrial applications, such as supplying the small amount of D.C. power necessary for cranes and other machines.

The unit-substation construction for sealed ignition rectifiers has become so convenient from the purchase and installation standpoints, that it will remain after the war on its own merits, both for electrochemical and general industrial applications.

ELECTROTHERMAL PROCESSES

Because of the diversity of this industry, it is difficult to give any statistical data on the additional kilowatt capacity of arc, resistance, and distillation furnaces installed in 1942. A large amount of kva was installed for producing magnesium by the ferro-silicon process, as discussed in recent technical literature.

One of the principal installations for producing magnesium by this process was made at a Pacific Coast plant which is already producing magnesium. This installation has a total installed capacity of approximately 60,000 kva in furnace transformers and thermal distillation transformers.

Another large plant begun in 1942 in the Pacific Northwest will start production early in 1943. This plant will have about 85,000 kva in furnace-transformers for the production of ferro-silicon and for the thermal distillation of magnesium by this process.

A ferro-silicon plant of about 37,500 kva in furnace capacity is being built in the east for the same purpose.

PETROLEUM AND SYNTHETIC RUBBER PROCESSES

During 1942 two additional gas turbines were manufactured to reclaim energy from natural gas that is burned in a carbon black plant, bringing to four the total of gas turbines installed in the carbon black process. Each of these gas turbines receives 165,000 cubic feet per hour of natural gas at a temperature of 450F at 225-pound gage. These temperature and pressure conditions are accumulated during the process. The turbines discharge at 5-pound gage into the further process.

Each of these turbines reclaims 150 kilowatts of electric power that would otherwise be wasted. Therefore, although small, these units are considered of significance since they indicate very real possibilities for further application in the chemical and petroleum industries. These industries are pressure and temperature industries, and wherever gas is processed under temperature and pressure, there are possibilities for reclaiming energy in the form of electricity. Accordingly, it is logical to expect an increasing number of such applications in the very near future.

SYNTHETIC RUBBER PROCESSES

The power plants now being installed in this industry include a 40,000-kilowatt steam turbine in a butadiene plant in the east, two 25,000-kilowatt steam turbines in a combination refinery and butadiene plant in the south, and a 35,000-kilowatt steam turbine in a butadiene plant in the southwest.

About half of the kilowatts generated by the large synthetic rubber plants will be returned to the public utility systems, while the remainder will be used in adjoining butadiene and polymerization plants. In one case, at least, some of the process steam will go to a polymerization plant erected in conjunction with a butadiene plant. The large majority of the steam requirements are, however, in the butadiene plant.

Speed in erecting plants is more essential now than is obtaining the last B.T.U., but it can be expected that after the war considerable refinement along the lines of heat balance and heat utilization will take place in synthetic rubber plants.

In conclusion, it seems evident that the tremendous impetus given to the chemical industry by the war will have a profound and even revolutionary effect on industry when peace returns.

SERVICING MANUAL

Following the same convenient pocket size and easy-to-read diagrams and text matters as appeared in the formula and data book, Allied Radio Corporation, Chicago, has published *The Manual of Simplified Radio Servicing* with 40 pages of charts, tables, diagrams, test meter connections, and RMA color codes.

Real modern practical servicing advice is given in the front portion of the pamphlet by J. G. Tustison, Major U. S. Army Signal Corps. His suggestions as to what procedure to follow when confronted with inoperative apparatus when one is without the usual bench testing apparatus should appeal strongly to all servicemen. His advice pertains to transmitters as well as receivers, so has all-round usefulness. The pamphlet costs 10c.

GUARDING COMMUNICATIONS WHERE THE GOING IS TOUGH!

SUPREME TESTING INSTRUMENTS

The famous 504-A and other SUPREME Testing Instruments are on active duty in all parts of the world. Now more ruggedly built, more accurate and dependable than ever. SUPREME Instruments will be your logical choice when victory is won.



SUPREME INSTRUMENTS CORP.

GREENWOOD, MISSISSIPPI

McELROY AUTOMATIC CODE TRANSMITTERS

ONLY FIFTY MACHINES FOR SALE

The famous McElroy Model G-813-742 Automatic Keyers with Tape Pullers.

These units are especially desirable for schools, colleges, group and individual code instruction.

All these Machines have been out on our rental service, brought in to be reconditioned and are offered for immediate delivery.

Price \$87.00 For complete G-813-742 including TP-890 Tape Puller.

ALL MACHINES SOLD WILL CARRY A NEW MACHINE GUARANTEE.

This Is the Last Lot of Machines Available Or That We Will Be Able to Offer for the Duration. ACT NOW For Prompt Delivery.

AYERS AUTOMATIC CODE MACHINES CO.

711 Boylston Street, Boston, Mass.

POPULAR ELECTRONICS

(Continued from page 523)

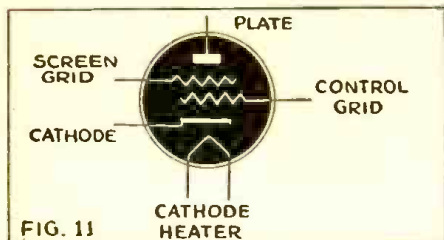

single envelope. The tube in question is used as a first detector-oscillator in super-heterodynes. The tube has five grids, Nos. 1 and 2 acting as grid and plate of a triode, while 3 and 5 are connected inside the envelope to accelerate the electron stream at the same time shielding grid No. 4 (for signal) from other electrodes.

Before our comment on tubes is closed (for the time being at least) some mention should be made of the so-called beam tube, the elements of which are illustrated in Fig. 14. A few paragraphs back, we mentioned the matter of secondary emission. The beam tube returns secondary electrons to the plate of a tube without the use of a suppressor grid. This is done with a negative space charge (minus and minus repel,

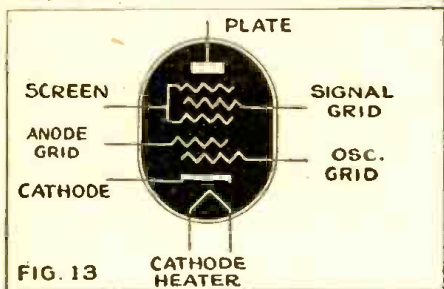
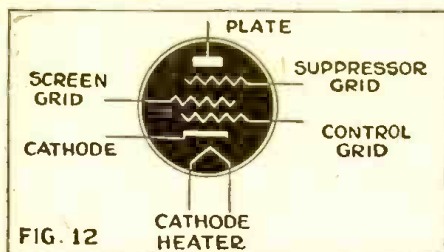

remember?) between the screen and the plate. In the beam tube, such space charges are generated and maintained by concentrating electrons in beams. In this way the space charge can be made so great as to drive all secondary electrons back to the plate.

A FEW EXPERIMENTS

Those with an experimental urge who wish to exercise their talents for investigation may confirm some of the statements that have been made in connection with vacuum tubes, especially the relation between plate current and cathode temperature, plate-current and grid charge, etc.

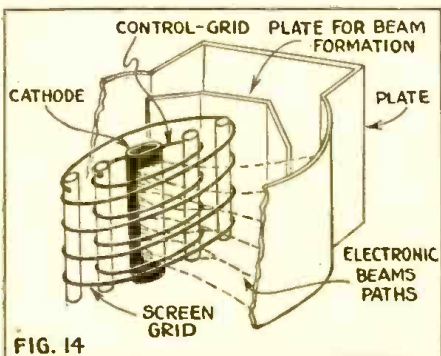

If a milliammeter is at hand, a number of interesting experiments may be conducted with the simple equipment and circuit shown in the photograph and in the drawing Fig. 15.

A three-element vacuum tube—either in new or second-hand condition—is required. A rheostat inserted in the cathode (filament) circuit may be used to adjust the temperature of the latter and suitable arrangements may be provided to adjust the values of the grid bias voltage. Changes in either one of these two variables will bring changes in the readings of the milliammeter in the plate circuit.

Another interesting experiment with magnetically bent cathode rays may be conducted with the equipment shown in Fig. 16 and the photograph. The object here is that of observing the effect of a magnetic field on electron discharge or cathode rays in an improvised tube. The glass tube

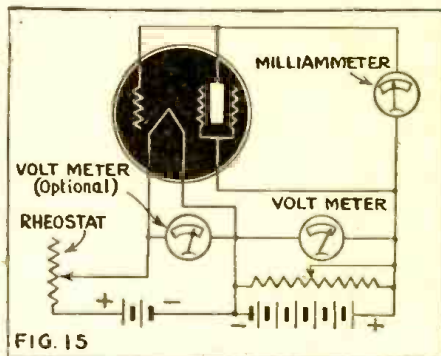

should be about four inches in diameter and eight or ten inches long. It may be opened at both ends but it will be necessary to have the ends ground perfectly flat and to have the end pieces perfectly flat also. Both are smeared with either vaselene or, better, some of the special compound made to seal joints where vacuum is to be produced.

The coil around the tube is formed with about 15 turns of No. 18 wire through which it will be necessary to send about 3 to 4 amperes to observe the bending of the electron discharge which will tend to form a circle if the magnetic field is of the correct value. Of course, the vacuum must be made relatively high and the Sprengel

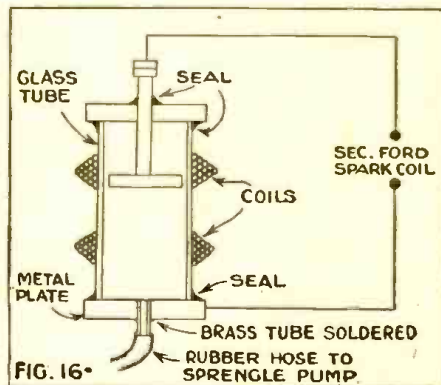

pump described in the last chapter may be brought into use. All connections must be perfectly sealed.

ELECTRON MOTOR DRIVE WITH 20-1 SPEED RANGE

(Continued from page 524)

armature and field adjustment on a single dial. Adjustment of the potentiometer changes the firing point on the A.C. line voltage wave at which the tubes fire and thereby varies the output D.C. voltage as required.

The normal speed range by armature control is 20 to 1, below the base speed of the motor, though a much wider range, such as 100 to 1 can be obtained. The total variation of speed is held to within 8% over the whole 20-1 range. Field control is used above basic speeds for standard motors. This is normally 2 to 1, but the top speed is limited by the mechanical limitations of the motor.

The standard electronic control automatically regulates the motor speed so as to maintain essentially constant speed at any setting regardless of load. Through other small control tubes, the D.C. voltage output of the main rectifier tubes is controlled to compensate for speed changes. In a properly adjusted system, the speed over a 10 to 1

range will not vary more than 4 per cent from a presetting, with torque varying from no load to full load. Nor will it vary more than 8 per cent for any speed within the

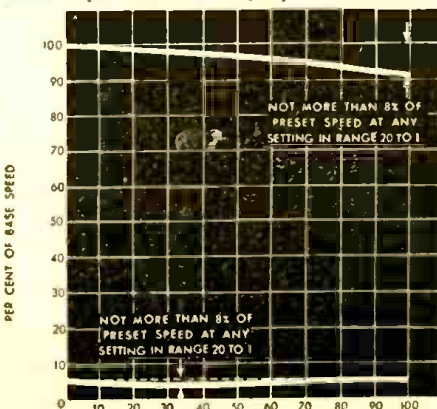

speed range of 20 to 1. Actual variations are shown in graphs 3, 4 and 5. Normal variations in A.C. line voltage have only a small effect on the speed regulation.

Motors furnished with this electronic control are selected to handle constant torque load over the entire armature control speed range (or up to the base speed of the motor) and constant horsepower over the field control range continuously without exceeding safe temperature limits. The frame size of the motor will depend upon the base speed rating and other operating characteristics. In most ratings it will be somewhat larger than the standard D.C. motor frame of the same horsepower and basic speed rating. The reason for a larger motor frame in most cases is because of the high form factor of pulsating current obtained from the rectifier when the firing angle is phased back to obtain low output voltage and consequently low motor speeds.

(Continued on following page)

MATHEMATICS FOR RADIO

Two volumes, prepared for home study. Book I (314 pp.) covers the algebra, arithmetic, and geometry; Book II (329 pp.) covers the advanced algebra, trigonometry, and complex numbers necessary to read technical books and articles on radio.

MAEDEL PUBLISHING HOUSE Room 102
593 East 38 Street, Brooklyn, New York
Send me MATHEMATICS FOR RADIO AND COMMUNICATION as checked below. I enclose payment therefor with the understanding that I may return the book(s) within 5 days in good condition and my money will be refunded.

Name

Address

- Book I at \$3.75 plus 6c postage
 - Book II at \$4.00 plus 6c postage
 - Books I and II at \$7.75 postage prepaid
- Foreign and Canadian prices 25c per volume higher

NOW—A REALLY HIGH-POWERED—Radio Engineering Library

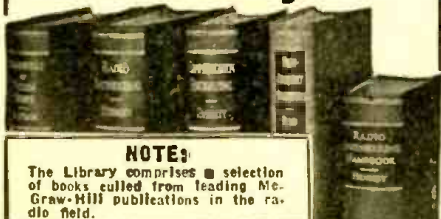

NOTE:
The Library comprises a selection of books culled from leading McGraw-Hill publications in the radio field.

- especially selected by radio specialists of McGraw-Hill publications
- to give most complete, dependable coverage of facts needed by all whose fields are grounded on radio fundamentals
- available at a special price and terms

THESE books cover circuit phenomena, tube theory, networks, measurements, and other subjects—give specialized treatments of all fields of practical design and application. They are books of recognized position in the literature—books you will refer to and be referred to often. If you are a practical designer, researcher or engineer in any field based on radio, you want these books for the help they give in hundreds of problems throughout the whole field of radio engineering.

5 VOLUMES, 3319 PAGES, 2289 ILLUSTRATIONS

1. Eastman's FUNDAMENTALS OF VACUUM TUBES
2. Terman's RADIO ENGINEERING
3. Everitt's COMMUNICATION ENGINEERING
4. Hund's HIGH FREQUENCY MEASUREMENTS
5. Henney's RADIO ENGINEERING HANDBOOK

10 Days' examination. Easy terms. Special price under this offer less than books bought separately. Add these standard works to your library now! pay small monthly installments, while you use the books.

10 DAYS' FREE EXAMINATION—SEND COUPON

McGraw-Hill Book Co., 330 W. 42nd Street, N. Y. C.
Send me Radio Engineering Library, 5 vols., for 10 days' examination on approval. In 10 days I will send \$3.00 plus few cents postage, and \$3.00 monthly till \$24.00 is paid, or return books postpaid. (We pay postage on orders accompanied by remittance of first installment.)

Name

Address

City and State

Position

Company RC 6-43

ELECTRON MOTOR DRIVE WITH 20-1 SPEED RANGE

(Continued from previous page)

The control is arranged so that the motor is always started at full field regardless of the setting of the speed potentiometer. If the speed is set above base speed, with weakened field, the speed control does not become effective and the field is not weakened until the motor reaches base speed. Fast, smooth acceleration is auto-

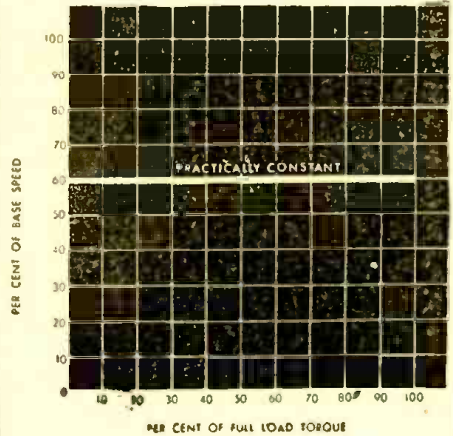

Fig. 5

matically obtained through a special current-limiting device built as part of the standard unit. The current-limiting device also works from a small auxiliary control tube that in turn controls the firing of the main rectifier tubes. Thus, the voltage output of the rectifier will be such that a preset current limit will not be exceeded. For general applications, the current-limiting device may be set over a wide range up to 200 per cent of rated full-load motor current, so that accelerating characteristics may be varied to suit load conditions. If unusually high starting currents are required the rectifier tubes must be carefully chosen for their peak ampere rating, even though the running load conditions do not exceed the average ampere tube rating.

The motor is quickly stopped with a dynamic braking resistor that is not in the motor circuit during running conditions. The amount of braking resistance is adjustable.

Vibration difficulties sometimes encountered with adjustable-speed drives have been minimized, as the D.C. motor is the only rotating part. No separate line starter or field rheostat is required. The electronic control may be mounted in its own cabinet or installed directly into the driven machine.

REACTANCE SLIDE RULE

How often have you gone frantic trying to match up micro-microfarads with microhenries in solving a resonant frequency problem? There's nothing to it with the new handy slide rule put out by Shure Brothers.

Filter problems; oscillator, impedance matching, bypass condenser problems—all these can be done as quick as a wink.

And of course all calculations in connection with microphones, line losses, and frequency, can be solved fast.

For those who work with formulae quite frequently this is a useful adjunct.

One side of the rule is devoted to resonance; such problems as correct coil and condenser combinations for a given frequency, design of audio tone-reinforcing circuits, and even the note of the code oscillator can be worked out with its help.

Index to advertisers

Allied Radio Corp.	548
Amperite Company	556
Amplifier Co. of America	565
Ayers Automatic Code Machines	572
Audel & Co., Theo.	Back Cover
Burstein-Applebee	565
Cannon Co., C. F.	566
Chartered Inst. of Amer. Inventors	569
Coyne Electrical School	515
Echophone	518
Fada of New York	566
Gold Shield Products	574
Hallcrafters, Inc.	Inside Back Cover
Harrison Radio	566
Hudson Specialties Company	570
Lapcaster, Allwine & Rommel	566
McGraw-Hill Book Company	574
Maedel Publishing House	574
Meissner Manufacturing Co.	561
National Radio Institute	513
National Schools	562
National Union Corp.	551
Nelson Company	567
Ohmite Manufacturing Co.	550
Opportunity Adlets	567
Panoramic Radio Corp.	567
Popular Homecraft	564

RADIO SCHOOL DIRECTORY

Candler System Co.	
Capitol Radio Engineering Institute	
Commercial Radio Institute	
Lincoln Engineering School	
Mass. Radio School	
N. Y. Y.M.C.A. Schools	
RCA Institutes, Inc.	
Radio-Television Institute	
Tri-State College	

Radecraft Publications, Inc.	555, 571
Radio & Technical Publishing Co.	545
Sprayberry Academy of Radio	517
Supreme Instruments Corp.	572
Supreme Publications Inside Front Cover	
Sylvania Electric Co.	516
Technifax	563, 564
Telex	569
Triplett Electrical Instrument Co.	556
Universal Microphone	564
University Laboratories	569
Wholesale Radio Labs.	565
Western Electric Company	567

(While every precaution is taken to insure accuracy, we cannot guarantee against the possibility of an occasional change or omission in the preparation of this index.)

LAWRENCE SLIDE RULES

With A, B, C, D, C1 and K Scales
FEATURES: Nickel Silver Framed Indicator with integral friction springs. Scales calibrated directly on well seasoned wood. Will retain accuracy regardless of temperature or humidity changes.



Instructions and illustrations clearly printed on back of rule for ready reference or teaching. Each rule in a durable pocket carrying case for convenience and protection.

The extremely low price of these slide rules and their absolute accuracy makes them ideal for the student as well as the working man who has always wanted to learn to use a slide rule.
LAWRENCE 10 inch white-enamelled slide rule with flat magnifier. In black case. Price, including 28-page instruction book No. 457... 60c
Secret Code Slide Rule, with 20-page book No. 458... 30c (2 for 50c)
28-page illustrated book of instructions, postpaid No. 459... 15c

GOLD SHIELD PRODUCTS

350 Greenwich St. (Dept. RC6) New York City

BOOK REVIEWS

ELECTRICAL COUNTING, by W. B. Lewis, M.A., Ph.D. Published by The Macmillan Co. Stiff cloth covers, 5½ x 8 inches, 144 pages. Price \$2.50.

Investigations in nuclear physics require apparatus to detect the presence or passage of atomic or subatomic particles. These particles, in passing through gasses, disrupt the electronic configuration of its atoms by collisions, leaving behind a trail of ionization. An electric counter consists of sensitive apparatus to detect this charged path, suitable amplifiers to increase the effect to a strength sufficient to operate a relay, and a mechanical device to record the number of impulses.

After discussing ionization chambers in one chapter, the author devotes a great deal of space to the design of suitable amplifiers, giving chapters to feedback and stabilizing circuits and to mixers, trigger circuits and discriminators.

The Geiger-Muller counter is discussed at considerable length, with analysis of the action and comparison of extinction circuits.

A chapter is given to mechanical recorders, and the three final chapters are devoted to the statistics of random distribution, coincidence counting and the determination of energy from range measurements.

X-RAYS IN RESEARCH AND INDUSTRY, by H. Hirst. Published by Chemical Publishing Co. Stiff cloth covers, 5 x 7½ inches, 127 pages. Price \$2.50.

This book covers matter given in a series of lectures before the Melbourne branch of the Australian Institute of Metals. It should be a satisfactory introduction to the subject for the metallurgist who is not familiar with the use of X-rays in industrial applications.

The theory of generation of X-rays is simply treated in a few pages at the beginning of the book. Considerable space is then given to X-ray examination of crystals.

The latter half of the book is devoted to the use of X-rays with metals, such subjects as investigation of alloy systems, measurement of thermal expansion coefficients and determination of grain size being treated. More detailed exposition of technique in industrial radiography is given in the section covering the principles of metal inspection.

The detection of flaws in welds and castings is discussed at some length.

A considerable number of X-ray photographs illustrate the subject well and add much to the text.

FUNDAMENTALS OF ELECTRICITY, by Morton Mott-Smith. Published by Westinghouse in cooperation with Science Service. Paper cover, 8¼ x 10 inches, 65 pages. Price 15 cents.

This little book is an extremely interesting first course in electrical theory and practice. Wherever possible experiments are described in connection with the lessons, and all are illustrated with very clear photographs and line cuts.

There are 40 lessons, covering the field from the basic principles of magnetism and static electricity to transformers, the telephone and current rectifiers. Each lesson ends with a "Do you know" self-examina-

tion section. The last page features the common electrical symbols and gives the student some hints on securing materials for experiments under war conditions.

A PRACTICAL COURSE IN MAGNETISM, ELECTRICITY AND RADIO, by W. T. Perkins and A. Charlesby. Published by Chemical Publishing Co. Stiff cloth covers, 5½ x 8½ inches, 312 pages. Price \$4.00.

The "Practical Course" has a unique approach. Divided into five sections, Magnetism, Direct Current, Alternating Current, Experiments on Motors and Radio, it begins each of the first three with an introduction "Definitions and Formulae." This is followed by a "Key to Experiments," actually a table of contents to the experimental section immediately following. There are 24 experiments in Magnetism, 45 in Direct Current and 17 in Alternating Current.

The formulas and theoretical sections pre-suppose a knowledge of high-school mathematics. The experiments are so written that they can be used both in class and by the independent student.

The section on motors is short, six experiments on direct-current machines being given.

The fifth section, "Radio," has a short introduction of formulas and definitions, followed by 16 experiments, ranging from determining the characteristics of a diode to checking the efficiency of a power transformer.

A short appendix includes an interesting page of tube symbols, in which the commoner European tube bases are shown. The book is well illustrated with line cuts.

RADIO TROUBLESHOOTER'S HANDBOOK, by Alfred A. Ghirardi. Published by Radio and Technical Publishing Co. Stiff cloth covers, 8½ x 11 inches, 744 pages. Price \$5.00.

Servicemen have been eagerly awaiting the new edition of the standard Troubleshooter's Handbook. The new edition retains all the familiar features of the older ones, with new material and special adaptations—such as tube interchangeability charts—necessitated by the very special conditions in the servicing business at this time.

Featured are 404 pages of trouble "Case Histories" giving all the common troubles and their remedies for over 4,820 receiver and automatic record changer models; a complete tabulation of I.F. peaks and alignment data for practically every known superhet receiver; a tube characteristics and basing data chart 17 pages long and giving complete information on the characteristics, operating voltages, classification, interchangeability and socket connections of 1042 receiving tube types.

In addition to this helpful information there are 133 additional pages containing 52 more specially prepared reference graphs, charts, tables and other compilations presenting vitally needed information on a wide variety of important subjects such as receiving tube types recommended for substitution, special purpose tubes, tube testing, receiver modernization, I.F. transformer

troubles, servicing and replacement, ballast resistors, dial lamps, coil winding, grid bias resistors, condenser replacement, transformers, all RMA and manufacturer's color codes for resistors, condensers, transformers, etc., parallel and series network calculations, logarithmic computations, decibels, volume and tone controls, filters, conversion factors, "time constants," reactance, electrical and radio servicing formulae, drills, screws and taps, trade directories of all manufacturers related to the radio industry, and others.

An important innovation in this new Handbook that both new and experienced servicemen will appreciate is the fact that every chart and data table is preceded by a clear, detailed explanation of its contents, together with instructions and *actual examples for its use*. This eliminates material "dead" to the owner because he does not understand the data as it is arranged, or does not know how to apply it to his needs. All data is arranged in quick-find tabular or chart form and is thoroughly cross-indexed.

Ghirardi's record as the author of successful text and reference books and his servicing experience are reflected in this practical servicing Handbook which should prove a welcome addition to the efficient serviceman's library.

HIGH-FREQUENCY THERMIONIC TUBES, by A. F. Harvey. Published by John Wiley & Sons. Stiff cloth covers, 235 pages. Size 5½ x 9 inches. Price \$3.00.

The general properties of thermionic tubes are first discussed, with attention to both positive and negative feedback, in the introductory first chapter of 22 pages. The attention to feedback indicates that the author is chiefly interested in oscillators, and indeed the book might almost have been entitled, "High Frequency Oscillating Tubes."

Influence of frequency on tube operation is next covered. References are chiefly to English tubes, most of which are identical with those of American manufacture, but are concealed under Osram or Standard Telephone type numbers. The technique of measurement at high frequencies is discussed in detail.

The author then covers high-frequency generators of the Barkhausen-Kurz type, with a not-too-fruitful account of the positive-ion technique of building slow-motion "models" of high-frequency tubes.

A full hundred pages are devoted to the Magnetron, the matter being divided into two parts and four sections. The first of these sections covers the theory of magnetic cutoff and general considerations of magnetron operation. The other three sections, Dynatron Regime, Resonance Regime and Electronic Regime, deal with the action of the magnetron oscillator under the respective conditions named.

The closing chapter of the book is divided between a discussion of velocity-modulated tubes and of short-wave guides and radiators.

The outstanding feature of the book is the simplicity of the language used. This makes it a very suitable text for the practical student. A second point worth noting is the complete bibliography at the end of each chapter.

Radio School Directory

TO OUR READERS—NOW IS THE TIME TO TAKE UP RADIO!

NOW, more than ever before America needs trained radio men. The Army, the Navy and the Air Force are continuously on the lookout for men who have had training in radio. Scores of war industries require radio men in various capacities throughout the country. There now is and there will be a great shortage of radio men for years to come. Reputable schools of Radio advertise to help you.



You should have this FREE 52-Page Book if you want good pay, adventure, interesting work! Army, Navy and Commerce need thousands of men who can send and receive Radio-telegraph Code. Learn Code at home or improve your proficiency and rating through the famous Candler System... the same easy, simple system used in training Radio-telegraph Specialists in Signal Corps, Navy, Marines, Coast Guard, Naval Reserve, Airlines and Amateurs. Big opportunity after the war in new fields on land, sea, and air. Qualify quickly through home study. No long-drawn-out studies. Candler System established over quarter-century. Candler System has trained T. R. McElroy, Official Champion Radio Telegrapher of the World, and other experts in telegraph communications. It teaches you fast sending and receiving technique at home. Tremendous new field for operators both in and out of Armed Services. Instruction for beginners and operators. You can learn code or increase your w.p.m. speed and improve proficiency. We help you qualify in half the usual time for amateur, commercial license, or high ratings.

Write today for FREE Candler Book of Facts. It costs you nothing.

CANDLER SYSTEM CO.

P.O. Box 928, Dept. 3-G Denver, Colo., U.S.A.
Craven House, 121, Kingsway, London, W.C.2

PRE-INDUCTION RADIO COURSES

Special Summer Course for High-School Students—of Special Interest to 17-year-old boys who may be called into Military Service.

NEW CLASSES NOW STARTING
● RADIO OPERATING ● CODE
● RADIO SERVICING

New York Y.M.C.A. Schools
4 W. 64th Street New York City

COMMERCIAL RADIO INSTITUTE

A radio training center for over twenty years. Well equipped. Excellent faculty. Practical resident courses in Defense, Radio Telegraphy, Broadcast, Servicing, Industrial, Television, Aeronautical, Drafting, Mathematics and Studio Technique. Placement bureau. Classes now forming for June 14. Catalog upon request. Dept. D, 38 West Biddle Street, Baltimore, Md.

LEARN RADIO

600 LICENSED graduates placed in past 7 years in shipping, broadcasting, aviation, police, etc.; we also teach radio servicing and repairing; new beginners' class now forming; 60-page catalog free; oldest, largest and best equipped.

MASS. RADIO SCHOOL

18 BOYLSTON ST., BOSTON, MASS., Est. 1899

TODAY—

is the time to
turn your RADIO JOB
into a SECURE POSITION!

Do you want a BETTER JOB—a SECURE FUTURE? Now is the time to prepare yourself for a lasting, profitable career in radio and industrial electronics. The good jobs—the permanent positions in radio don't come easy. The sure way to success is to build your future on a sound foundation of knowledge and ability—and the ability that you develop now is your assurance of a steady, sure income that will outlast such temporary conditions as exist today. CREI technical home study training is designed to do just one thing—to increase your ability, enabling you to hold the more responsible positions which lead to higher salaries.

WRITE TODAY! If you are a professional or amateur radio-man and want to make more money—let us prove to you we have something you need to qualify for the better job opportunities that can be yours. To help us intelligently answer your inquiry—please state briefly your education, radio experience and present position.



CAPITOL RADIO ENGINEERING INSTITUTE

Dept. RC-6, 3224 16th St., N. W., Wash., D. C.

RADIO ENGINEERING

RADIO Engineering offers unusual opportunities for WOMEN as well as MEN. B. S. Degree. Modern laboratory, latest equipment. Courses also in Civil, Electrical, Mechanical, Chemical, Aeronautical Engineering; Business Administration, Accounting, Secretarial Science. Special Preparatory Dept. Tuition, living costs low. Enter Sept., Jan., March, June, 60th year. Catalog. TRI-STATE COLLEGE 2463 COLLEGE AVE. ANGOLA, INDIANA

DEGREE IN 27 MONTHS

RADIO TECHNOLOGY

RCA Institute offers an intensive two-year course of high standard embracing all phases of Radio and Television. Practical training with modern equipment. Also shorter specialized courses in Commercial Radio Operating, Radio and Television Servicing, and Aviation Communications. For Free Catalog write Dept. RC-43.

RCA INSTITUTES, Inc.
A Radio Corporation of America Service
75 VARICK STREET NEW YORK

Correspondence Courses in
RADIO and ELECTRICAL ENGINEERING

ELECTRICAL ENGINEERING Get good grasp of wide electrical field. Prepare yourself, at Low Cost, for secure future. Modern, simplified, you can understand quickly.
RADIO ENGINEERING Extra fine course in radio, publishing, etc. address, photo-electric work. Trains you to be super-service man, real vacuum tube technician. Servicemen needed badly. Diploma on completion. Tuition \$25, either course. Deferred payment plan.
FREE Get copies of school catalogs, student magazines, complete details. SEND NOW!

LINCOLN ENGINEERING SCHOOL Franklin Sitn., Box 61-C52 WASHINGTON, D. C. (Formerly at Lincoln, Nebr.)

RADIO-TELEVISION VITAL to War Effort

Enroll now with new groups. Opportunity under war conditions and real future in peacetime.

RADIO-TELEVISION INSTITUTE
Dept. R. C.
480 Lexington Ave., New York, N. Y.

RADIO MEN AND WOMEN NEEDED

MEN and women are sought to fill positions as technical and scientific aids in the Federal Government. They are needed for testing and research work in the following fields: Radio, physics, meteorology, metallurgy, chemistry, mathematics, and geophysics.

The positions pay \$1620 to \$2600, plus overtime.

Applicants may qualify through experience or education. For the assistant grade, applications will be accepted from persons who have completed 1 year of paid experience or a war training course approved by the U. S. Office of Education. One year of college study, including 1 course in the option applied for, is also qualifying. Persons now enrolled in war training or college courses may apply, subject to completion of the course. For the higher grades successively greater amounts of education or experience are required.

The majority of the positions are in Washington, D. C., the remainder in other parts of the United States. There are no age limits, and no written test is required. Applications and complete information may be obtained from first- and second-class post offices, from civil service regional offices, and from the Commission in Washington, D. C. Applications will be accepted at the U. S. Civil Service Commission, Washington, D. C., until the needs at the service have been met.

Trainee positions in technical and scientific work will be filled in Washington, D. C., and vicinity. The salary is \$1,440 a year plus overtime, and the only educational requirement is that the applicant must have completed one high school credit of physics, chemistry, mathematics, biology, or general science. There are no options.

Persons using their highest skills in war work are not encouraged to apply. War Manpower restrictions on Federal appointments are given in Form 3989, posted in first- and second-class post offices.

RESISTORS AND HEAT

THE passage of a constant current of electricity through a resistor will soon raise the temperature of the unit until a constant value is reached. This steady temperature will be determined largely by the relation of the size of the resistor to the wattage being dissipated, the shape of the resistor, the material of which it is made and the ventilating conditions.

The last mentioned factor, ventilation, or the degree of enclosure plays a very important part in the final temperature attained by a resistor. In the graph above, the lower curve shows the temperature that a typical vitreous enameled resistor will attain for various percentages of its rated wattage when it is mounted where it is surrounded by at least one cubic foot of air having unrestricted circulation. The upper curve shows the temperature the same resistor will attain when it is mounted in a certain metal box having restricted air circulation. This curve illustrates strikingly that the maximum permissible temperature (when the resistor is enclosed) is reached at only 60% of the rated wattage. In general the rated wattage of resistors mounted enclosed, or where several resistors are located close together, should be considerably greater than the wattage to be dissipated (the exact amount greater is dependent upon individual conditions).—Ohmite News



Improved in War!

... for Better Peace-Time Reception

The rigors of modern warfare are the world's finest proving grounds for communications equipment . . . constant usage and unusual operating conditions in every climate are a severe test of the communications receiver. Hallicrafters equipment is proving its high quality performance capabilities with our armed forces.

Hallicrafters communications receiver Model SX-28 (illustrated) 15 tubes, 6 bands, delivers outstanding reception . . . your peace-time model will be worth waiting for.

hallicrafters

CHICAGO, U. S. A.

The World's Largest Exclusive
Manufacturer of Short Wave Radio
Communications Equipment

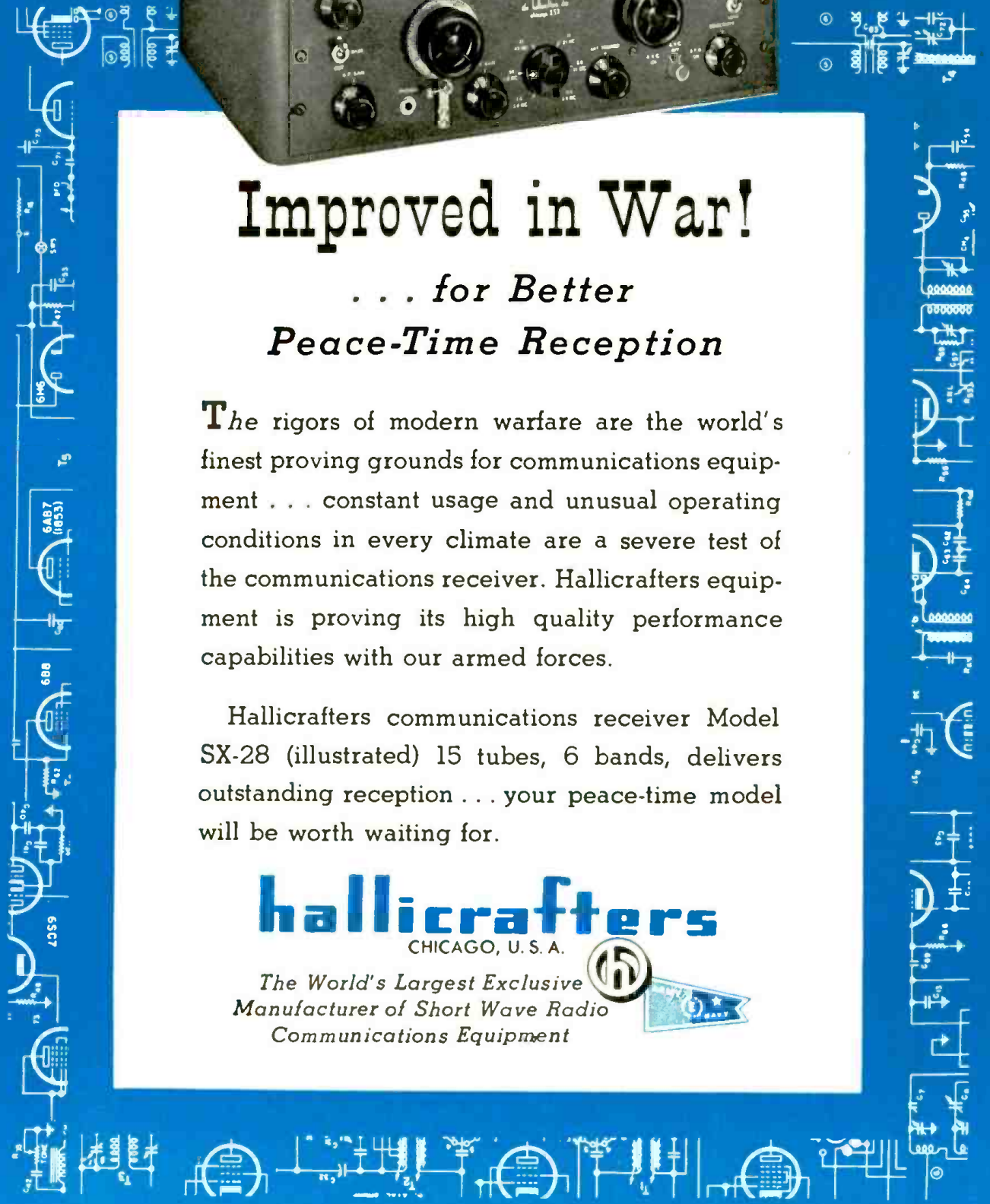

Audels -MANS RADIO GUIDE

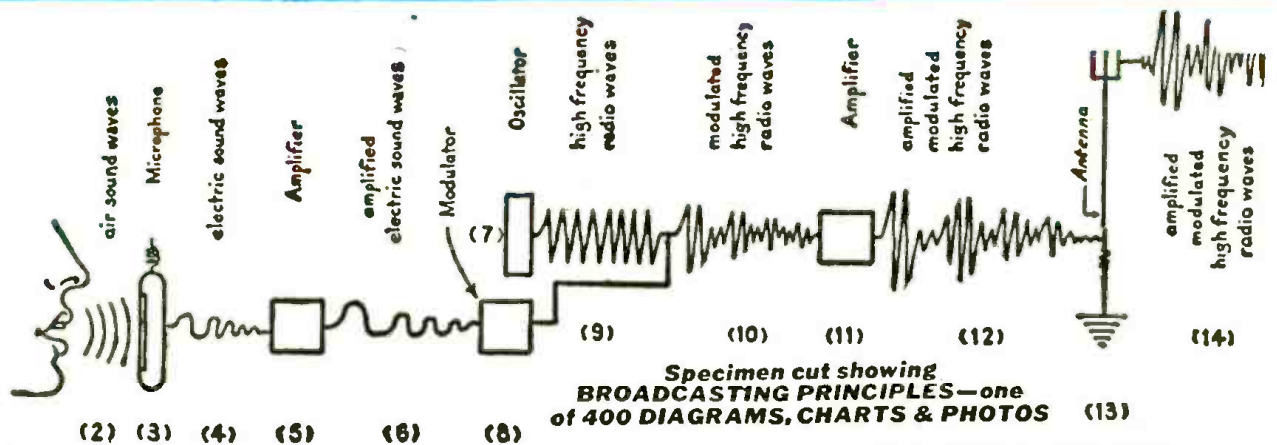

(1)
QUESTIONS
AND
ANSWERS

1001
FACTS

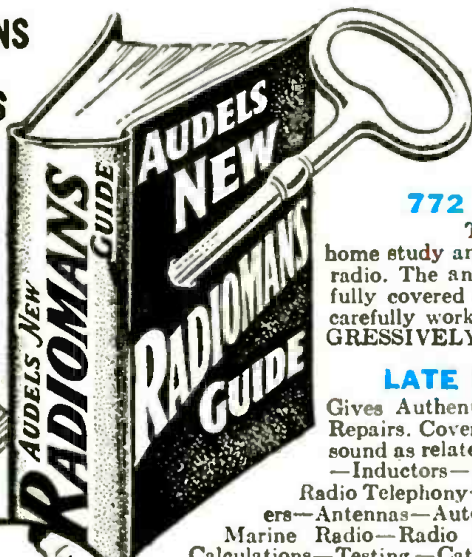

THE KEY TO PRACTICAL RADIO INFORMATION

Including Frequency Modulation—Television, etc.

Inside Information for Aviation, Marine, Commercial Operators
and Technicians, Servicemen and Students

772 PAGES, 400 DIAGRAMS, CHARTS & PHOTOS

This well organized reading course in Radio is especially suitable for home study and as a ready reference guide to help you learn the inside facts about radio. The amount of mathematics required for a successful study of this book is fully covered as the various chapters include numerous practical radio problems, carefully worked out, step by step, to their final solution. The contents are PROGRESSIVELY ARRANGED AND CAREFULLY INDEXED.

LATE DATA—EASY TO READ AND UNDERSTAND

Gives Authentic Principles and Practices in Construction, Operation, Service & Repairs. Covers clearly and concisely Radio fundamentals—Ohm's Law—Physics of sound as related to radio science—Measuring instruments—Power supply—Resistors—Inductors—Condensers—Transformers and examples—Broadcasting stations—Radio Telephony—Receivers—Diagrams—Construction—Control systems—Loudspeakers—Antennas—Auto Radio—Phonograph pickups—Public Address Systems—Aircraft & Marine Radio—Radio Compass—Beacons—Automatic Radio Alarms—Short Wave—Coil Calculations—Testing—Cathode ray oscillographs—Static Elimination—Trouble Pointers—Underwriter's standards—Units & tables. REVIEW QUESTIONS—Ready Reference Index.

HIGHLY ENDORSED—ASK TO SEE IT ON 7 DAYS' FREE TRIAL

MAIL COUPON TODAY

THEO. AUDEL & CO., Publishers, 49 West 23rd St., New York

Mail AUDELS NEW RADIOMAN'S GUIDE for free examination. If O.K. I will send you \$1 in 7 days; then remit \$1 monthly until \$4 is paid. Otherwise I will return it.

Name.....

Address.....

Occupation.....

Reference.....

RCF

**\$4 COMPLETE
PAY \$1 A
ONLY 1 MO.**

ADV Plans, LLC

Copyright Notice:

The entire contents of this CD/DVD are copyright 2014 by ADV Plans, LLC. All Rights Reserved.

Reproduction or distribution of this disk, either free or for a fee is strictly prohibited. We actively monitor and remove listings on eBay thru Vero.

You are free to copy or use individual images in your own projects, magazines, brochures or other school projects.

Only the sellers listed here are authorized distributors of this collection:
www.theclassicarchives.com/authorizedsuppliers

Please view our other products at
www.theclassicarchives.com,
or our ebay stores:

[TheClassicArchives](#)
[ADVPlans](#)
[SuperShedPlans](#)

